



---

## **SOLUTIONS FOR ALUMINIUM ROLLING MILLS**

TECHNOLOGY, MECHANICAL  
ENGINEERING, AUTOMATION AND  
ELECTRICAL ENGINEERING FROM  
A SINGLE SOURCE - CUSTOMIZED  
SOLUTIONS THAT FIT YOUR NEEDS

## YOUR CHALLENGE

# A GROWING NEED FOR PLANT PRODUCTIVITY AND QUALITY ROLLED PRODUCTS

### GROWING MARKETS

Driven by global demand, the market for aluminium strip and foil continues to grow. China's aluminium demand exceeds that of all other countries and will continue to do so in the coming years. Steady growth means plants in areas outside China must continually optimize aluminium rolling processes in order to stay competitive. Increased rolling speeds and increased plant productivity are key factors for securing your position in the market.

### IT'S ALL ABOUT QUALITY

Although being able to increase quantity is important, the key factor is quality enhancement. The ability to provide aluminium strip and foil in customized qualities is becoming increasingly crucial. Your customers in aerospace, automotive, commercial transportation and packaging as well as construction require even tighter tolerances. To meet these demands, you need a flexible, easily adaptable rolling setup.

### FLEXIBILITY IS A MUST

As your customers' market needs change, your plant must be capable of adapting. Short delivery times and fast production changeover are key criteria when end customers decide where to place orders. Dealing with product changes is therefore a vital factor in the economics of aluminium rolling. Logistic design has to be part of the plant solution, too.

### THE NEED TO DRIVE COSTS DOWN

Rising raw material costs also have to be considered. In recent years, the price of aluminium has risen sharply. This means waste reduction is an important target.

### HIGH PLANT AVAILABILITY

Plant operations need to be optimized to increase capacity and improve quality while decreasing operating costs. Easy maintenance is also important for improving plant availability and strengthening long-term performance.

With ever greater demands for aluminium strip and foil, the need for increased mill productivity and availability, better product quality and enhanced reliability continues.

### YOU EXPECT

- Leading process technology that delivers high-quality products
- Fast rolling speed and flexible production processes
- Tailored and comprehensive solutions that accommodate the increasing quality demands for aluminium products
- Expandable solutions that protect your investments into the future
- High plant availability that lowers operations costs
- Long-term performance with services that meet your needs

# OUR SOLUTION

## CUTTING-EDGE TECHNOLOGIES FOR ALUMINIUM ROLLING MILLS

### THE ANSWER FOR THE ALUMINIUM INDUSTRY

Our solution has everything to bring aluminium rolling mills up to speed. This includes the most powerful roll drives for higher throughput. State-of-the-art mechanical and hydraulic solutions optimize performance and operational efficiency. Online process models and neural networks will enable you to produce more accurately than ever before, and our proven automation solutions maximize your plant's end-to-end consistency, reliability and security in the future.

### INCREASED PRODUCTION

With our decades of experience, Primetals Technologies has a deep understanding of processes in the aluminium industry. Through the seamless integration of technology, mechanics, automation and electrical engineering, our solutions can help your plant achieve its highest level of productivity.

### IMPROVED QUALITY

We use a wide range of specialized technologies like DSR® (Dynamic Shape Roll), SmartCrown®, Non-contact shape measurement, Automatic Gauge control (AGC), automatic profile and flatness control and more to achieve highest product quality.

### EFFICIENCY FROM MILL STANDS TO PRODUCTION PLANNING

Our automation technology allows you to respond quickly to your customers' requirements and achieve market driven, flexible production. A modular strategy, open communications and transparent automation architecture ensure that the solution fits your needs, whether you're building a new plant or modernizing an existing one. Intelligent application-specific solutions and globally proven drive concepts, guarantee reliable plant operation throughout the entire production process. Maintaining the highest product quality and ensures plant availability, you'll lower your operating costs significantly.

### CUSTOMIZED PRODUCTION

Customers today want aluminium strip and foil to meet different sizing specifications. They also want small batches and good prices. That means you need fast and flexible production processes that produce higher yield through reduced cropping, trimming and off-length losses. Our solutions minimize scrap from trimmed edges to help you achieve unrivalled cropping and width optimization.

### OUR SERVICES ENSURE YOUR SUCCESS

Our professional services are aimed at helping your plant achieve top performance throughout its entire life cycle. Customized preventive and predictive strategies let you minimize unplanned downtime and reduce your costs on maintenance, spare parts and personnel.

Our experience ranges from hot rolling to the finished product. This allows us to meet the demands both upstream and downstream - and to build the mill that perfectly fits your requirements.

### ADVANTAGES OF PRIMETALS TECHNOLOGIES

- Universal partnership - Primetals Technologies is your single-source supplier for mechanical, electrical and automation equipment
- Top quality - our cutting-edge technologies help you improve quality significantly
- Greater efficiency - modular automation packages allow you to fine-tune your processes to fit your current needs
- Higher yield - intelligent process control helps you reduce waste significantly
- Optimum reliability - comprehensive maintenance and service offerings ensure the highest availability of your plant

# OUR PORTFOLIO AT A GLANCE

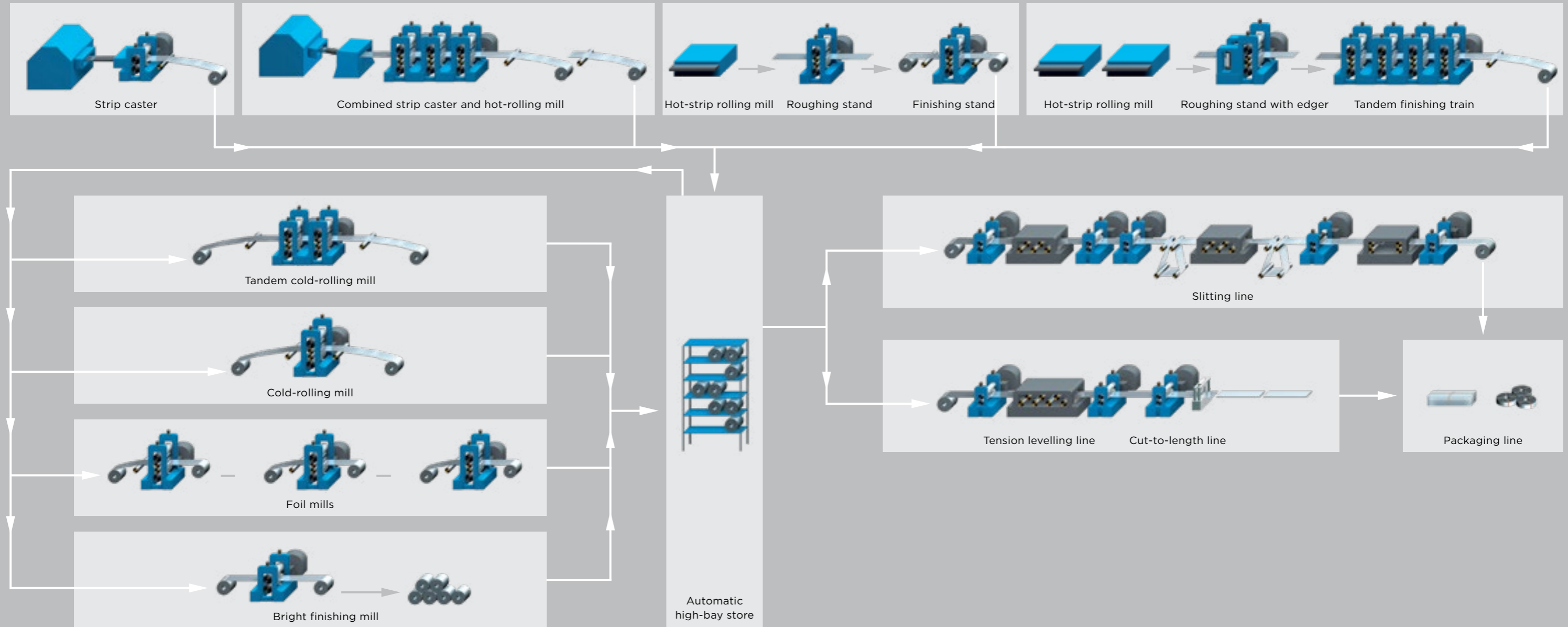

## CONTENTS

### Aluminium mills

Hot mills	8-9
Cold mills	10-11
Foil mills	12-13

### Supplies and services

Life-cycle management	14
Service	15
Modernization	16-17
Special products	18-19
Drive solutions	20
Automation solutions	22-23
Process optimization	24
Innovation	25
Selected references	26-27

## PRIMETALS TECHNOLOGIES' OFFERS THE FULL RANGE OF ALUMINIUM MILL SOLUTIONS

As your life-cycle partner, we'll team with you to meet all your needs, including:

- investment planning,
- operating concepts and layout
- modernization

We ensure that your plant is always using the latest technology. We have a proven track record for conducting complex integrated rolling complex projects and supplying process equipment. We can also define, supply and install auxiliary facilities including roll shop, annealing, finishing and packaging equipment. In addition, we can identify

building and civil engineering costs associated with different layouts or planning for future plant expansion for increased production. Service is another key element that Primetals Technologies' delivers. From the training of operation and maintenance personnel to the supply of knowledge and total plant maintenance service, Primetals Technologies' has the expertise to meet your requirements.

# HOT ROLLING MILLS

## ADVANCED TECHNOLOGY FOR HIGH-QUALITY PRODUCTS



Chinalco Ruimin - mill build

Our portfolio features a full range of aluminium hot rolling mills for both new and revamp projects.

These include:

- Reversing roughing mills
- Tandem mills
- Twin-coiler mills
- Plate mills
- Mini mills

With our flexible mill configuration, you can roll high quality strips in capacities from 100,000 to 800,000 tonnes per annum, depending on the installation. Product technologies are focused on achieving the highest-quality products. Primetals Technologies provides advanced mechanical actuators, electrical and automation control systems and applied process knowhow to deliver gauge, profile/flatness, temperature and surface quality with the highest level of consistency. Advanced roll stack actuators such as SmartCrown and DSR can be custom-selected according to your specific mill design.

### FEATURES

- Our mill stand equipment is designed for the highest rolling loads and main drive torques, which ensures the correct development of material property and maximized throughput.
- Hydraulic systems to provide controllable, responsive, precise, safe and efficient operation. These include hydraulic edger, Hydraulic Gauge Control (HGC), work roll bending and shifting, side guides and shears.
- SmartCrown roll contour guarantees enhanced flatness control.
- For perfect cooling and contour control we provide pulse-modulated work roll spray bars.
- An accurate mill setup is crucial for meeting the demands for quality. Our range features physically based analytical online models supported by neural networks to achieve tight tolerances right from head end.
- Common technological solutions to enhance performance, operability, maintenance, safety and environments are utilized across the hot mill, such as strip coolant blow-offs, fume hoods and fume extraction.

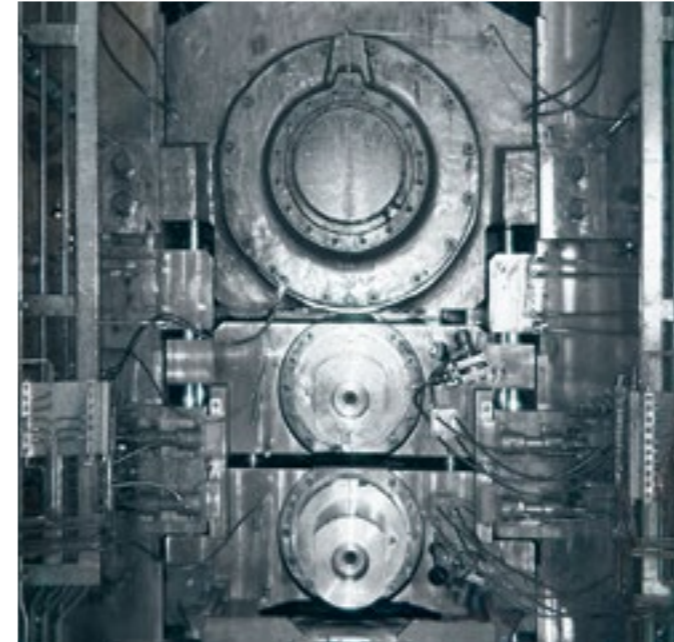

Tandem mill window

### TYPICAL PRODUCT RANGE

Strip thickness:	1.5 - 8.0 mm
Strip width:	600 - 2,600 mm
Coil weight:	+30 t
Spec. coil weight:	+15 kg/mm
Alloys:	1xxx - 8xxx grade

### MAIN BENEFITS

- Flexible, low-cost rolling of a wide range of products, even for small order lots
- Tightest strip thickness and profile flatness tolerances
- Maximum yield due to hydraulic edging with automatic width-control functions
- High surface quality
- Most advanced and innovative automation
- Integrated health and safety concepts



Novelis 3 Stand Hot Mill

### SELECTED REFERENCES

- Alcan, Pindamonhangaba, Brazil
- Alcasa, Puerto Ordaz, Venezuela
- Alumax, Texarkana, USA
- Alunorf, Neuss, Germany
- Chinalco Ruimin, Fuzhou, China
- Chinalco NELA, Harbin, China
- Compania Valencia de Aluminio (CVA), Segorbe, Spain
- Novelis Korea, Ulsan, South Korea
- SouthWest Aluminium, Chongqing, China
- TLM, Sibenik, Croatia
- Furukawa Sky, Rayong, Thailand
- China Steel Aluminium, Kaohsiung, Taiwan
- Nanshan Aluminium, Nashan, China
- Aleris, Zhengjiang, China

# COLD ROLLING MILLS

## SOLUTIONS FOR HIGH-PRECISION ROLLING



Henan Cold Mill, China



CBA, Sorocaba, Brazil

The cold mills supplied by Primetals Technologies offer a unique blend of innovative design and proven technology, allowing strip to be produced at very tight tolerance and high productivity levels.

Our mills provide both breakdown and finishing capability, offering flexibility for the production of a wide product range from a single mill configuration. The fully integrated automation and drive system enables automated equipment sequencing for efficient mill operation. Process control, which uses the latest Primetals Technologies automation technology, assures the online control of strip flatness and gauge and allows for the production of high-quality products such as can stock, lithographic sheet and foil stock.

Our portfolio includes:

- Breakdown mills
- Thin-strip mills
- Tandem mills (2 and more stands)

The cold rolling process can be assigned to different process applications, each suited to the material finish requirements.

**Breakdown mills** are available as the more conventional process option. These mills can be 4-high or 6-high design and provide the flexibility to operate on the complete range of alloys, over a wide gauge range of around 10 mm – 0.05 mm. Capacities of up to 150,000 tonnes per year are achievable with this process.

**Tandem mills** with 2, 3 or 5 stands can be used to extend the throughput capacity to 300,000 tonnes per year and more.

**Thin-strip mills** of 4-high design allow for a finishing capacity on light gauges of down to around 0.02 mm. This mill type can be used for foil roughing applications. Capacities vary and depend on the application, but are usually in the order of 30,000 tonnes per year.



Heavy Duty, Standard and Light Duty Shapemeter Rotors

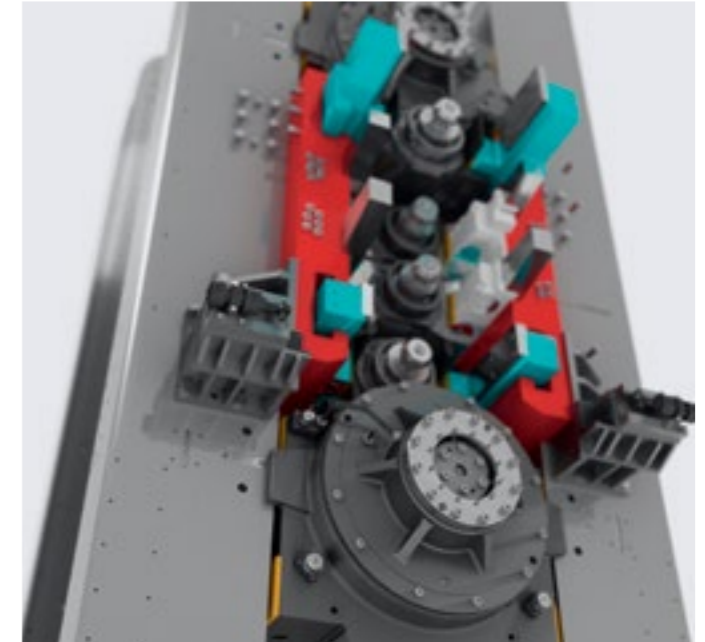

6-high millstand

### MAIN BENEFITS

- To ensure an accurate mill setup, our cold rolling mills are based on physical online process models. This plus our fully integrated process control, automation and drive systems allow for optimum rolling results at any time.
- We offer a range of mill stand technologies to suit the particular requirements of your project. Options include DSR backup roll technology, SmartCrown roll technology and 6-high stand design.
- Edge Wipe technology enhances the Primetals Technologies' strip drying system, addressing the edge bead issue common on open gap passes.
- The Vapour Shield fume cleaning and oil recovery system ensures environmentally friendly operation and the efficient collection and retrieval of rolling oil.
- The appropriate choice among a range of flatness sensors is available:
  - A non-contact flatness sensor, ideal for surface critical applications
  - Air Bearing Shapemeter roll, particularly suited to thin-gauge finished products.
- The Schneider roll coolant filter, manufactured and supplied under license by Primetals Technologies, is the market leading filter, enabling high levels of filtration and long cycle times with its Acticel R filtration media.

### SELECTED REFERENCES

- Highest production rates
- Optimized yield
- Flexible production
- Tight tolerances for strip thickness, flatness, and high surface quality
- Low costs for operation, maintenance, and minimum downtimes

### SELECTED REFERENCES

- Alcoa, Samara, Russia
- Alcoa (KAAL), Moka, Japan
- Alcoa Bohai, Qinhuangdao, China
- Aluar, Abado, Argentina
- Aluminium Konin, Konin, Poland
- CBA, Sorocaba, Brazil
- Chinalco Henan, Zhengzhou, China
- Chinalco NELA, Harbin, China
- Comital, Volpiano, Italy
- Elval, Inofyta, Greece
- South West Aluminium, Chongqing, China
- Furukawa Sky, Rayong, Thailand
- China Steel Aluminium, Kaohsiung, Taiwan
- Mitsubishi Aluminium, Mishima, Japan

# FOIL ROLLING MILLS

## BEST QUALITY AT THE LOWEST COST



Foil mill, Shanghai Shenhua, Shanghai, China



Foil mill, Novelis, Bridgnorth, United Kingdom

Primetals Technologies range of high-performance foil mills combines the latest developments in measurement, computing and control with innovative mill design to enable you to produce the best-quality foil at the lowest cost.

The mills feature a number of automated systems for coil, spool and scrap handling as well as high-speed work roll change. The design puts you in sync with the market trend toward larger coil weight combined with wide strip to maximize yield and productivity. The fully integrated automation and drive system enables automated equipment sequencing for efficient mill operation. Process control, which uses the latest Primetals Technologies automation technology, ensures the online control of strip flatness and gauge and allows for the production of high-quality products.



Foil mill line and coil yard

### FEATURES

Our state-of-the-art high-speed foil mills (all types) have a number of specific features:

- Operation and drive-side work roll latching allows for thermal expansion of the rolls to the operator side. Accommodated by bearing clearances, this eliminates potential thrust forces on the mill spindles and work roll bend rams during long passes.
- Operation and drive-side backup roll latching similarly eliminates potential thrust forces on the roll load cylinder during long passes.
- An optimized mill bearing design with specifically tailored tolerances enhances high-speed operation.
- Oil circulation lubrication to the backup roll bearings maintains bearing temperatures within their operating range and allows for the use of synthetic oils, which have a better load carrying capability.
- A work roll and backup roll bearing temperature measurement function ensures precise monitoring of the bearing temperatures.
- A constant-force ironing roll permits consistently higher coiling speeds.
- Spindle piloting eliminates potential roll vibration by providing a positive location of the roll neck in the spindle end.

### MAIN BENEFITS

- High production rates
- Flexible production
- Tight tolerances for strip thickness and flatness
- Low costs operation, maintenance, and minimum downtimes

### SELECTED REFERENCES

- NorthWest Aluminium, LongXi, China
- Shanghai Shenhua, Shanghai, China
- Varopakorn, Bangkok, Thailand

# LIFECYCLE MANAGEMENT

## PARTNERSHIP NEVER ENDS

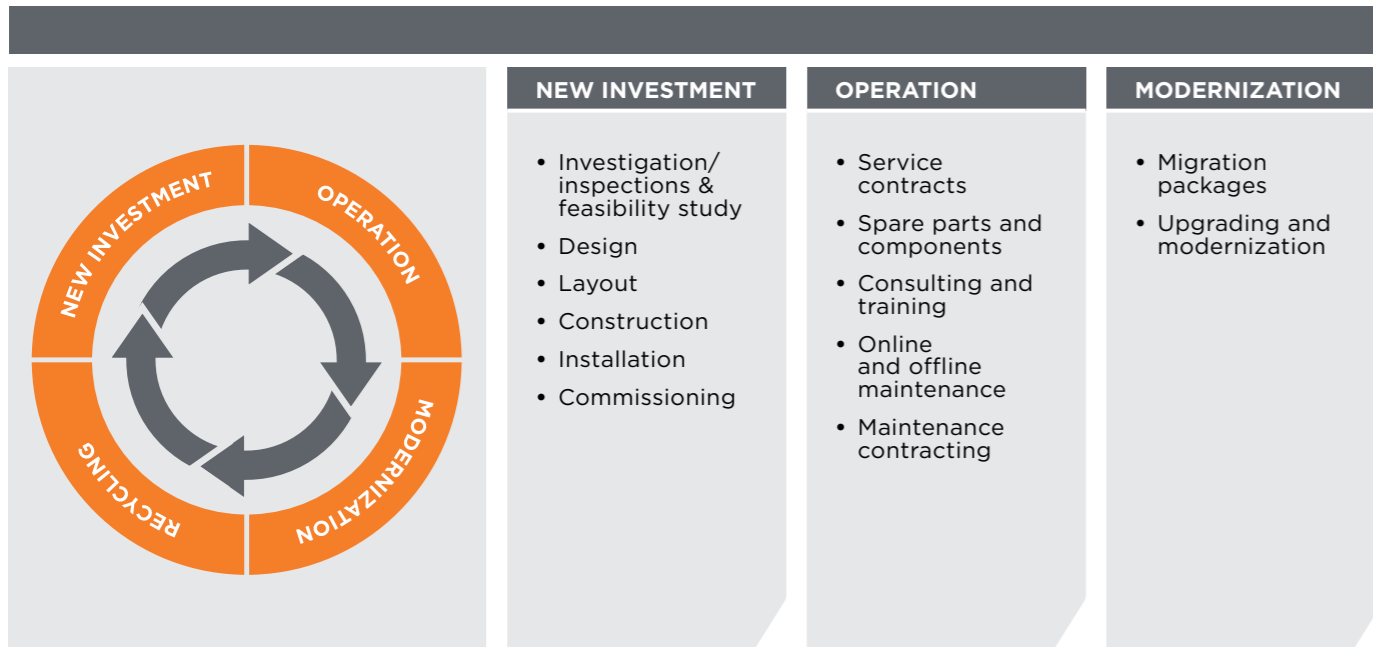

### PRIMETALS TECHNOLOGIES LIFECYCLE SERVICES

As a plant operator, you have conflicting needs. On the one hand, your performance is measured each quarter against short-term profitability expectations. On the other hand, you have to think on a totally different timescale compared with the capital market. Depending on the lifetime of your plant, you have to take 15 years or more into account. At the very least, that's 60 full quarters.

But thanks to our comprehensive expertise and integrated approach to solutions, you benefit both short-term and long-term from our life-cycle services. In the short term: Backed by our extensive experience with many reference plants, we provide you with the certainty of fast, dependable production start-up and shorter amortization periods.

In the long term: Our master plan guarantees competitive performance for your plant in every phase of its life cycle. Whether we're providing 24/7 technical support, optimizing maintenance, or making permanent plant improvements, we are always working to ensure the cost-effective operation of your plant.

You want your plant to produce at competitive costs over its entire life cycle, and always have state-of-the-art technology.

That's why you make an investment. For this investment, you should expect an effective life-cycle concept from your plant manufacturer.

# OUR SERVICES

## BEST PERFORMANCE THROUGHOUT YOUR PLANT'S LIFETIME



### SERVICE FOR ELECTRICAL EQUIPMENT AND AUTOMATION

The maintenance of your production facilities and equipment is a significant cost factor for you. Yet unplanned process downtime greatly affects the earnings of the entire company. Risks must be minimized, as must the costs for keeping those risks small.

Services offered by Primetals Technologies range from planning, consulting and engineering to the supply of both individual components and complete production lines, including safe and rapid start-up. Whether we're constructing new plants or modernizing existing capacities, our own training specialists make sure that your personnel know how to handle the process and technology safely and efficiently.

### OUR OFFERINGS INCLUDE ...

- Pre-sale studies from design, engineering and feasibility studies to improvement studies
- Start-up support from on-site training to accelerated start-up programs

### FEATURES

- Dedicated spare parts service from small proprietary items to major assemblies
- Stock control and distribution database
- Standard packages with measurable client benefits
- Dynamic spare parts and material management system
- Material information system
- Substitution of parts including re-engineering



# MILL MODERNIZATION

## KEEPING YOUR PRODUCTION UP-TO-DATE

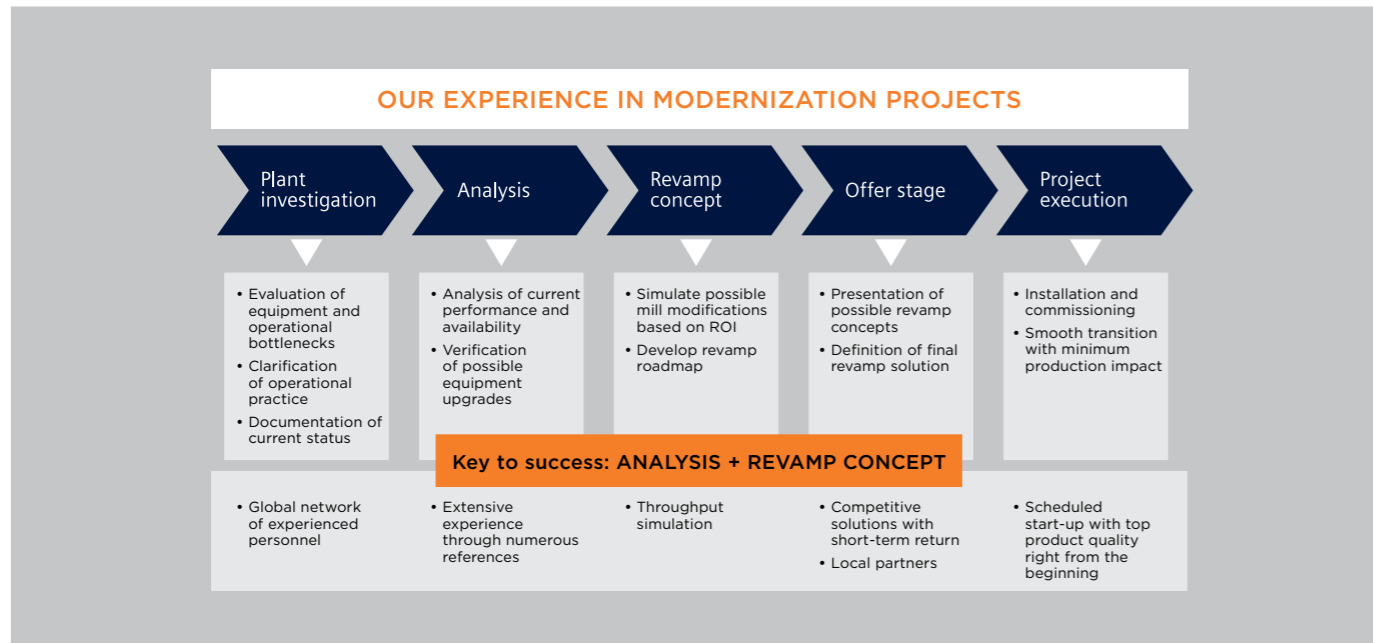

Systematic approach for target-oriented modernizations

To remain competitive as an aluminium producer, you need the latest and most advanced technologies that ensure the best product quality and output. This is particularly true in the field of rolling mill modernization, where complex mechanical and hydraulic equipment components must be integrated with sophisticated process control systems in order to respond to market demands.

Primetals Technologies provides solutions that can be implemented through a phased upgrade with a minimum of downtime in ongoing plant operations. This approach allows the mill to improve its production output, maintainability, machine access and product quality, helping you to remain competitive and successful. The solution may be purely electrical, automation, mechanical or a combination thereof, and can be carried out in one or more steps during a plant shutdown.

**Primetals Technologies experience minimizes downtimes and ensures fast start-up and top quality.**

A successful modernization project starts with the selection of one of three types of modernization strategies:

- Type 1: Mill modernization via ongoing and continuous improvements and investments
- Type 2: Mill modernization via one or two major modernization steps
- Type 3: Mill modernization via relocation and improvement of an existing mill



Novelis Utinga, Santo Andre, Brazil after foil mill modernisation

### SELECTED REFERENCES

- Alcoa, Samara, Russia
- Alcoa Bohai, Qinhuangdao, China
- Alcoa Europe, Kofem, Hungary
- Aleris, Koblenz, Germany
- Alunorf, Neuss, Germany
- Hindalco, Renukoot, India
- Hydro Aluminium, Grevenbroich, Germany
- Kumz, Kamensk-Uralsky, Russia
- Logan Aluminum, USA
- Nikkei Siam, Bangkok, Thailand
- Novelis Korea, Yeongju, South Korea
- Novelis Packaging, Bridgnorth, United Kingdom
- Novelis UK, Rogerstone, United Kingdom
- Novelis Utinga, Santo Andre, Brazil
- Garmco, Bahrein
- Alcoa Europe, Spain
- AMAG, Austria
- Novelis Oswego NY, USA
- Novelis Ulsan, South Korea
- Novelis Pinda, Brazil
- Constellium Singen, Germany

## SPECIAL PRODUCTS

# UNIQUE SOLUTIONS TO IMPROVE THE PERFORMANCE OF YOUR MILL

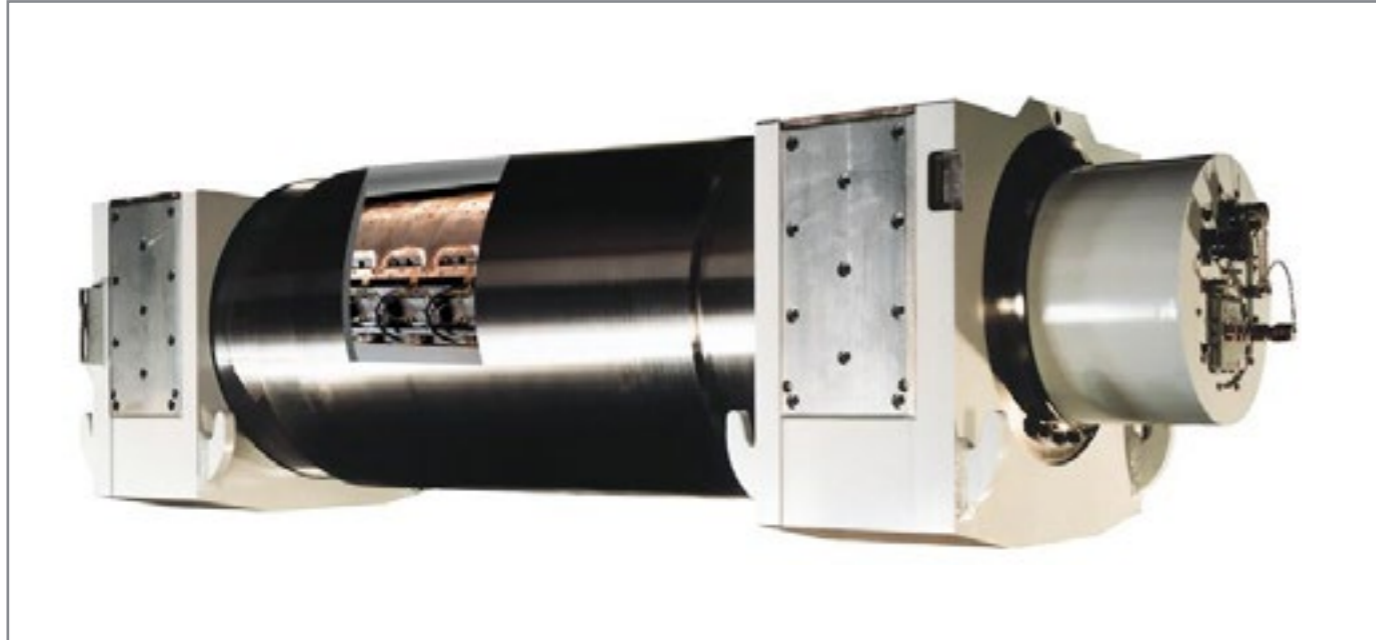

Dynamic Shape Roll (DSR®)

One of the strengths that sets Primetals Technologies apart from the competition is our decades of experience, both in machine engineering and automation. Our special products combine expertise from both areas to create unsurpassed solutions. Proven mechanical designs, optimized control technology and clearly defined interfaces deliver a solid foundation for flexibly expanding existing aluminium rolling mills or constructing new plants from a single source. And these solutions are modular in design, making them ideal for efficiently modernizing plants in easy-to-manage projects.

### DSR® - DYNAMIC SHAPE ROLL

The DSR® system from Primetals Technologies is a key technology for enhancing the performance of cold rolling mills. DSR® replaces the top solid backup roll usually employed in 4-high stands. It provides improved flatness control, especially in the critical areas at the head and tail ends of the strip. This allows for significant improvements in overall coil yield. Currently, DSR® is the only truly online dynamic actuator that can enable symmetric and asymmetric changes to the roll gap profile during ongoing production.

### SMARTCROWN® WORK ROLL CONTOUR

Work rolls are equipped with SmartCrown® (patent pending), a new type of roll contour introduced by Primetals Technologies. Employing work rolls shifting in conjunction with specially profiled work rolls significantly increases the flatness control range. SmartCrown is usually installed in combination with work roll bending to enable profile and flatness control. With SmartCrown's large adjustment capability, only one grind is needed to replace all roll grinds for conventional rolls.

### NON-CONTACT FLATNESS MEASUREMENT SYSTEM

This non-contact system helps to you achieve greater precision and productivity in flatness control. It is based on the principle of periodically exciting the strip and measuring the excitation amplitudes across the strip width. In practice this means:

- High resolution of measurement
- Independence from strip speed
- Elimination of the need for special coating or surface treatment
- Maintenance that can be performed by your maintenance staff
- Elimination of the need for spare devices



Non-contact - flatness measurement and control

### FLATNESS PACKAGE

Our flatness solution includes all required mechanical actuators and measurement and control systems to ensure the highest flatness performance. Depending on the mill type and product mix, the mill stands feature:

- Work roll bending
- Multizone cooling ISV Sprays - enabling local corrections
- Hot-edge sprays - addressing tight-edge issues
- Induction heating - addressing tight-edge issues
- Hot-edge sprays - addressing tight-edge issues
- DSR® - giving fully dynamic control
- SmartCrown® - allowing for continuous crown adjustment

These actuators work in conjunction with a range of flatness sensors, including:

- Air bearing shape roll - high sensitivity, particularly suited for foil production, but also available in a cold mill, heavy duty version
- Non-contact measurement for highest surface demands
- Placinim® shape roll - robust, solid roll available for hot and cold applications

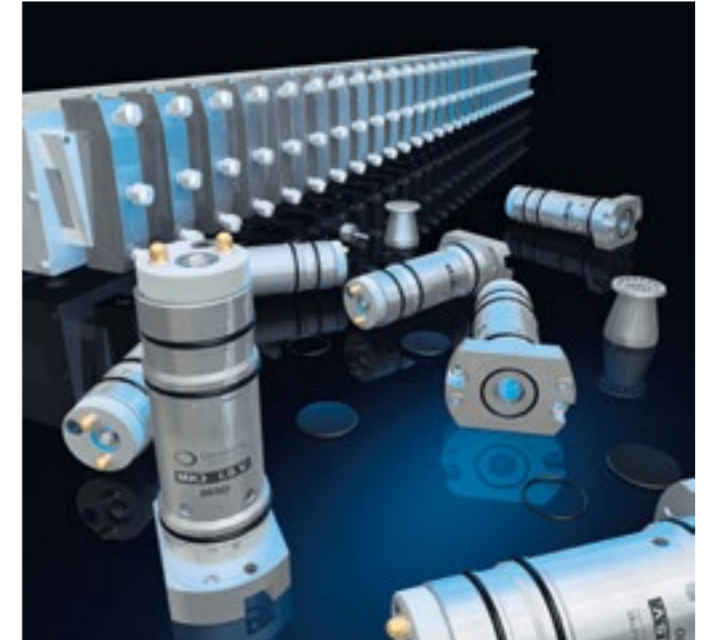

ISV spray systems

### AGC PACKAGES

Primetals Technologies' automatic gauge control (AGC) packages combine the hydraulic capsules, servovalves, transducer and control system to create a comprehensive solution. Mass flow control ensures thickness precision to within a few thousandths of a millimetre. Our REC (roll eccentricity compensation) and CECO (coil eccentricity compensation) system also allows for improved thickness performance, especially for modernizations.

### COOLANT COLLECTION AND FILTRATION SYSTEMS

Primetals Technologies offers a selection of rolling oil treatments, including:

- Schneider Filter - a multiplate filter designed and made under license by Primetals Technologies, providing microfiltration
- Vapour Shield fume cleaning and oil recovery system, providing effective emission control and recycling of recovery rolling oil

Further products offered by Primetals Technologies:

- Edge Wipe which removes the coolant edge bead prevalent in cold rolling, thereby improving exit coil dryness
- Constant-force ironing roll with optimized geometry and servocontrol to maintain straight coil build-up throughout the coil
- Scratch brushes that are work roll chockmounted, with precise hydraulic loading

# SPECIAL PRODUCTS

## UNIQUE SOLUTIONS TO IMPROVE THE PERFORMANCE OF YOUR MILL



Edge Wipe - Coolant Bead removal system

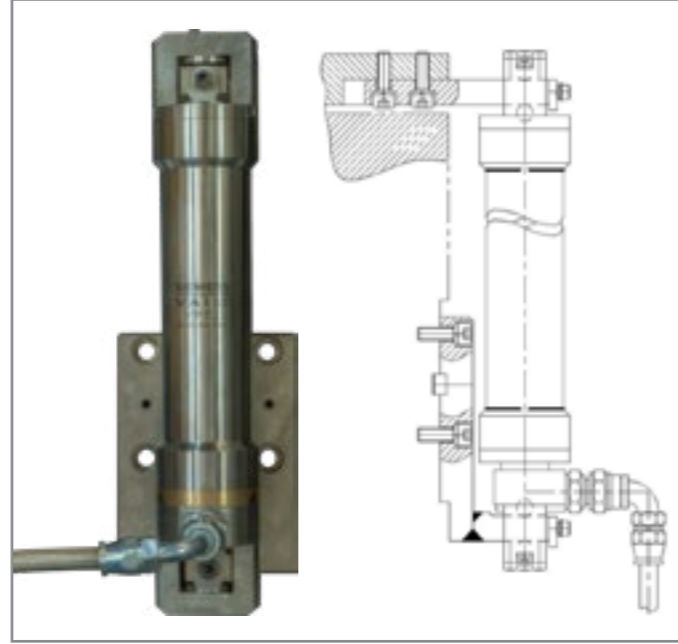

VPT3 - Mill Position Transducer



Integral Solenoid Valve Spray Bar

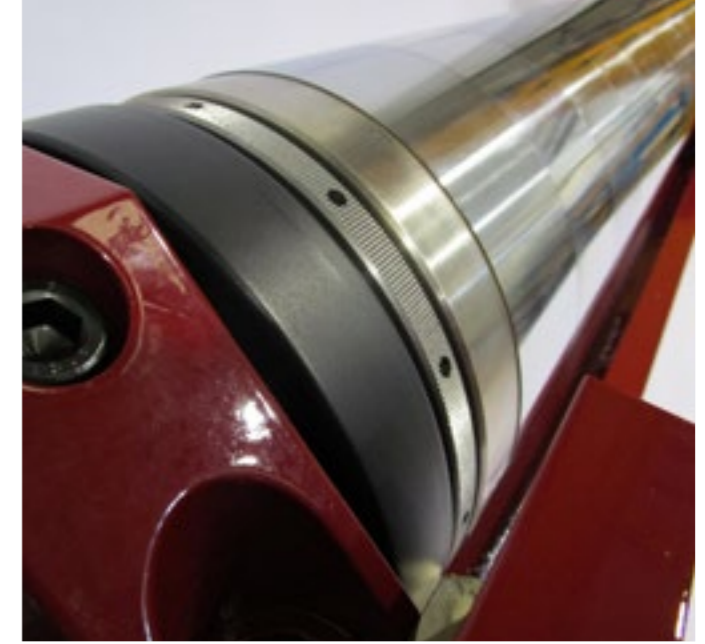

Air Bearing Shapemeter Roll

### COOLANT CARRY OVER CONTROL

The Primetals Technologies Edge Wipe, is designed to work in conjunction with conventional mill strip drying equipment in order to specifically address the problem of coolant edge bead carry over.

Coolant edge bead is caused by the open gap in the roll bite outside of strip width. The coolant bead on the strip edge, if then not removed, contaminates the finished coil by coolant ingress into the coil body.

The unit is designed to be mounted in the mill exit table, close to the mill bite and features the following:

- Independently indexing heads
- Infra-red edge tracking system
- Self-adjusting carry over plates

### BENEFITS

Controlling edge bead coolant provides the following benefits:

- Improved coil stability and telescoping
- Reduced material staining
- Reduced operating and external environmental contamination

### VPT3 MILL POSITION TRANSDUCERS

A range of mill position transducers specifically designed for the harsh environment of the rolling mill. Mounted to the hydraulic capsule and offering self-aligning capability and zero backlash due to the unique mounting system.

### BENEFITS

- Specifically designed for rolling applications
- All stainless steel construction
- High resolution measurement
- Self-aligning mounting arrangement
- No bellows
- No compression springs
- Incorporates either Magnescale or Temposonic technologies
- Strokes available from 25mm upwards

### ISV SPRAY TECHNOLOGY

The ISV spray technology is a well proven system for applying roll coolant to flat product rolling mills. With over 350 references worldwide the ISV is one of the most versatile spray systems available today.

Suitable for all rolling applications from hot mills to foil mills its simple design ensures reliability whilst advanced thermal modelling ensures correct nozzle selection for each and every application.

### BENEFITS

- No sliding parts in valve
- Compatible with kerosene and water based Coolants
- Excellent tolerance to mill contaminates
- Stainless Steel Valve construction
- Front access to valve / solenoid
- Pulse Width Modulated (PWM) capability providing 10:1 flow level turndown

### SHAPE MEASUREMENT

The air bearing shapemeter roll was first introduced in the early 1970s just as shape control on flat product mills was being introduced. Now available in a range of 3 diameters and with rotor widths available from 25mm wide, the rolls may be configured to suit any application.

The air bearing is one of the most sensitive shape sensors available and can now be offered with Automatic Trend Alignment which further increases its accuracy and serviceability.

### BENEFITS

- High sensitivity
- Continuous output
- Low inertia - No drive
- Simple on-site maintenance
- Compact design
- Large reference list

# SPECIAL PRODUCTS

## UNIQUE SOLUTIONS TO IMPROVE THE PERFORMANCE OF YOUR MILL



Automatic Trend Alignment

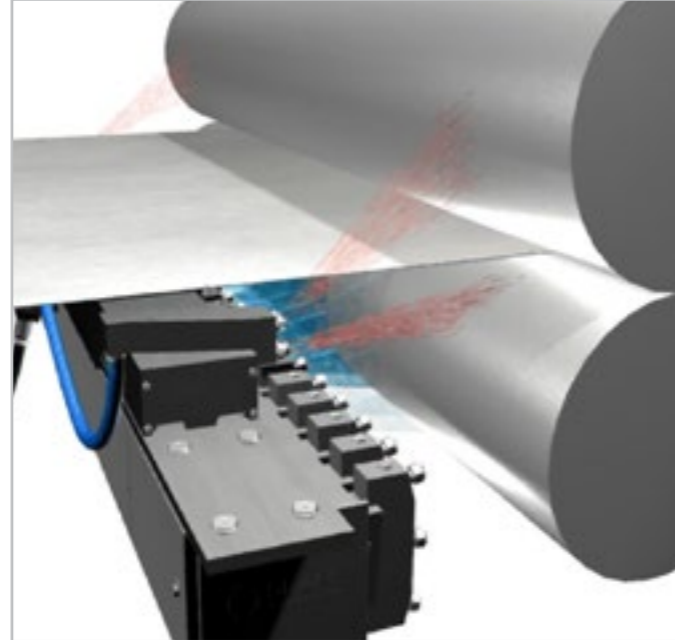

Hot Edge Spray Header

### AUTOMATIC TREND ALIGNMENT

Alignment is particularly important on any flat product rolling mill and failure to maintain alignment can cause strip and shape problems both online and downstream.

The air bearing shapemeter roll in particular benefits from correct alignment both in terms of overall sensitivity and reduction of wearing components. Even a perfectly aligned mill can produce thrusting emanating from the material being rolled.

The Automatic Trend Alignment (ATA) for air bearing shapemeter applications is the ultimate solution to ensure the highest sensitivity of shape measurement together with improved reliability. The ATA is available not only on all new applications but may also be retrofitted onto existing.

### BENEFITS

- Automatic operation
- Thrust sensing
- Improved sensitivity
- Reduced component wear

### HOT EDGE SPRAYS

The Primetals Technologies unique solution to applying hot coolant outboard of strip edge is centred around two position controlled individual hot coolant spray headers. This gives the maximum amount of flexibility as to where the hot coolant is sprayed for optimum results.

Benefits include the reduction of the work roll thermal gradient at the strip edge to eliminate inboard pockets and tight edges.

### BENEFITS

- Infinitely adjustable position
- Proprietary spray nozzles
- Compact design
- Bottom or top spray bar mounting
- More controllable strip edge shape
- Increased mill speeds



Schneider Filter

### SCHNEIDER FILTRATION

Coolant filtration is an essential element in the rolling and forming of all metals. Primetals Technologies supplies the Schneider Coolant system for all rolling applications.

Offering very high levels of filtration for both mineral oils and emulsions, it maintains the coolant in "as designed" condition, extending the life of the roll coolant.

### BENEFITS

- Improved filtration performance
- Improved product quality
- Patented green filter media is safe to handle, no dust hazard.
- Reduced waste streams, zero waste available
- Eliminate coolant dumps
- Low operating costs
- Improved process performance

# DRIVE SOLUTIONS

## MOVING THE ALUMINIUM INDUSTRY



Reliable and high-quality synchronous main drives for very demanding applications



Maintenance-free cylindrical rotor

In aluminium rolling, interruption-free processes and high-quality end products are important. The crucial demands placed on drive technology are therefore high. Dynamic response of the control system and brief overload capability, smooth running, maximum availability, service friendliness and seamless integration into higher-level automation systems.

For over two decades, Primetals has pioneered main drive technology for rolling mill applications. With an installed base of AC main drives with a combined capacity exceeding 1 GW (1,000 MW), Primetals has extensive experience in delivering reliable, high quality main drives for demanding rolling mill applications.

### INTEGRATED DIGITAL DRIVE SYSTEMS

Fully digital, integrated systems with full diagnostic performance have been designed for drive control with high speed multi-microprocessors.

Flexible applications range from single drives with pinion gears to integrated drive systems for twin-drive and tandem-drive, from DC converters to AC cyclo-converter drives and AC multilevel drives, covering a wide range of power and voltage ratings. Comprehensive software development tools and libraries are supplied as part of the system. Diagnostic capabilities with local display of messages, operator control and monitoring are included in the applications.

### MAIN BENEFITS

Primetals Technologies provides the full range of main drives and auxiliary drives systems. Our expertise covers the entire range from the power supply to the motor, thus we can ensure a fully integrated solution to achieve the highest quality and reliability.



# AUTOMATION SOLUTIONS

## COMPLETE PROCESS CONTROL AT EVERY LEVEL



### MODERN AUTOMATION CONCEPT FOR IMPROVED PRODUCT QUALITY

Technological controls and process models are the core of any modern automation concept with the goal of maximizing utilization of the mechanical, electrical, hydraulic and other controlled equipment. The control concepts have evolved with the increasing performance of the equipment and increasing demands in terms of tolerances of the final product - from simple analogue PI controllers to highly complex and interlinked control systems. These controls and process models are nowadays integrated and the added value is well visible in the rolled strip.

#### These added values are:

- improved gauge tolerances,
- less off-gauge material,
- Perfect profile and flatness to meet growing demands worldwide.
- Maximum throughput

### REALISTIC PHYSICAL MODELS

Primetals Technologies relies on more than 30 years of experience in the development of physical models for rolling processes. Thanks to our continuous collaboration with our customers, universities and metallurgical research institutions, we now have detailed models for the entire rolling process. These provide a solid foundation for our leading automation solutions, especially in the area of aluminium technology.

### PASS SCHEDULE CALCULATION AND MILL SET-UP

Based on ingot or strip data and customer target specifications for the finished product, our process control system ensures that your production is fast and efficient. We achieve this through fully automatic pass schedule calculations and intelligent plant setups that are self-adjusting on the basis of measured process data. Such features allow you to avoid production bottlenecks and maximize plant throughput. You achieve shorter production cycles and outstanding material quality right from the very first strip.

#### A CASE IN POINT

### PERFECT TEMPERATURE CONTROL IN HOT MILLS

Our sophisticated temperature model takes all physical effects into account, including heat conduction into the work rolls, frictional heating, deformation heating and convective and radiative heat transfer into the atmosphere and cooling water. An intelligent adaptation algorithm refines the heat transfer coefficients (rather than simply applying a correction factor to the final result). The model takes into account the actual physics of rolling heat transfer through adaptation, results of which can be applied across different plants.

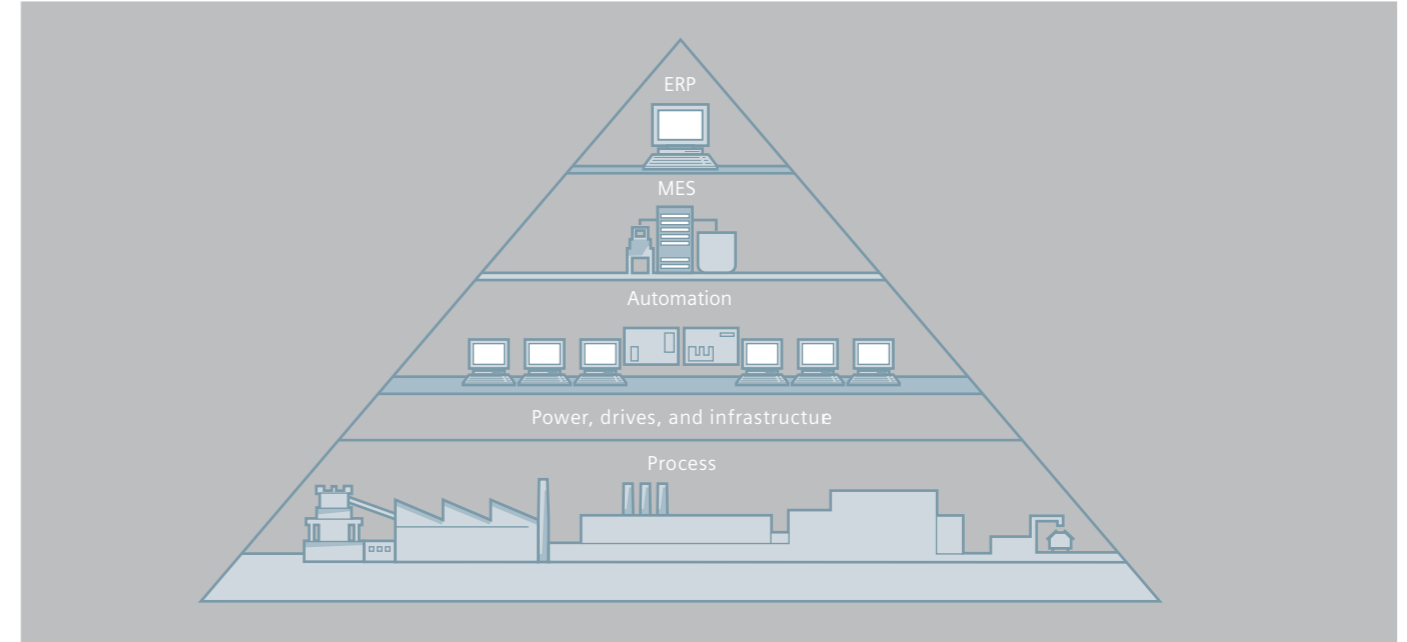

Leading automation solutions on all plant levels - from the field up to the management level

### ANOTHER EXAMPLE

Setup calculation for strip threading. In a cold mill, the phase when the strip is threaded and the mill is accelerated to the desired speed is particularly critical. A wrong initial setting can lead to strip breaks or cause poor mill acceleration. The setup calculations based on our mathematical models help circumvent this by precalculating the mill setting just before the actual strip is threaded, based on the current mill status. All necessary aspects such as the roll wear and temperature, initial roll profile and incoming strip profile are taken into account by means of our sophisticated mathematical models. The online adaptation is performed by means of neural-network technology.

### PROFILE AND FLATNESS CONTROL

Strip geometry involves not only width and thickness, but also profile and flatness measures. To meet the specifications of the market, our profile and flatness control system builds on sophisticated physical models. A roll temperature model, for example, analyzes the asymmetrical conditions on the roll surface, while a material flow model calculates the roll pressure distribution as well as the strip flatness after each pass. Based on this data, the profile and flatness control system makes sure that the finished strip has the desired profile or contour and flatness. The profile and flatness controllers fully incorporate and exploit the capabilities of available actuators such as SmartCrown, roll bending, DSR and roll cooling.

### MANUFACTURING EXECUTION SYSTEM (MES) SOLUTION

The Production Management Systems support the Optimization of the entire supply chain from the receipt of a customer order through to final product delivery. Aluminium producers must cope with increasing complexity in product and order mix. Tight due dates for product delivery, influenced by last-minute-changes by customers makes just in time production inevitable, resulting into high planning and logistics requirements. The Primetals Technologies' Production Management Systems overcome these challenges. The solutions consist of a set of modular components, configurable to customer's specific requirements. Covering manufacturing execution, stockyard logistics, quality management & control, advanced planning & scheduling.

Mastering production processes requires fully understanding and mapping them in physical-metallurgical models.

Modelling allows you to identify the effects of individual parameters on the entire process. Good models are therefore critical for the precise control of the plant.

# PROCESS OPTIMIZATION

## SPECIFIC SOLUTIONS FOR YOUR ENTIRE PLANT

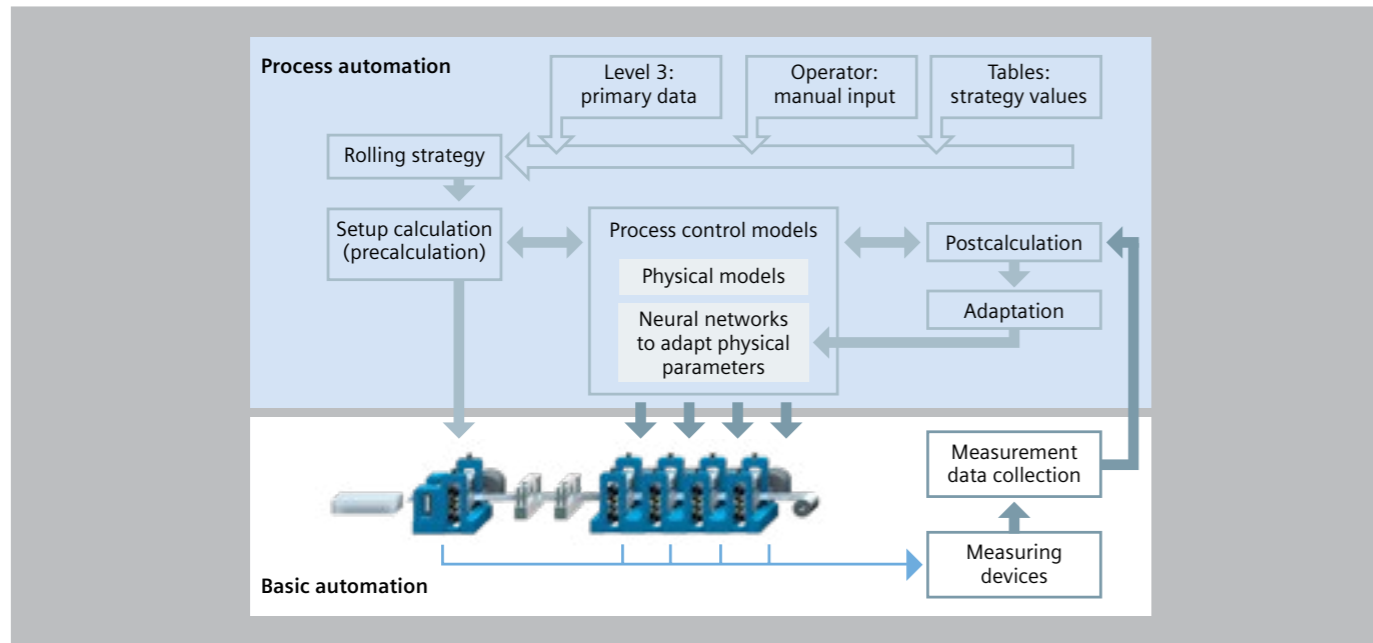

Our process optimization, process control and basic automation technology guarantees stable processes and greater system reliability, as well as custom solutions to meet your needs right from the design phase.

### SCALABLE SOLUTIONS

The Primetals Technologies solutions for the entire automation and drive system are scalable to your specific requirements. Solutions can range from simple pass schedule storage to a complete pass schedule optimization and setup system that includes the generation of all relevant production result data for product quality tracking and analysis.

### AUTOMATION SYSTEM

The process control system is based on a unique combination of international industry-standard hardware and software components and expertise in aluminium rolling that has been acquired through decades of experience in mill automation. It provides excellent quality tolerances together with easy service and spare part access and maintenance. The remote access features give you access to support from our specialists no matter where you are.

### TECHNOLOGICAL CONTROLS

We offer the full range from AGC/AFC packages to fully integrated mill automation and drive systems. The technological controls includes a complete set of sophisticated control algorithms for hot, cold and foil applications. All features are carefully integrated with the related drive system and mechanical equipment to enable optimum results.

### HMI AND DIAGNOSTICS

The automation system provides easy-to-understand HMI (human-machine interface) screens and features targeted diagnostics to provide excellent operator guidance.

# EXPERTISE FROM EXPERIENCE

## SELECTED SUCCESS STORIES IN ALUMINIUM ROLLING



### HIGH PRODUCTION, HIGH QUALITY

**Customer.** Chinalco Ruimin, Fuzhou, China  
**Plant type.** Hot rolling mill  
**Our solution.** 3-stand tandem finishing mill  
**Technical data.** Width 1,050 - 2,250 mm; thickness 2.5 - 10.0 mm  
**The result.** Production of 370,000 t/a of high quality hot rolled strip from 2010



### ALWAYS AT THE LEADING EDGE

**Customer.** Chinalco Northeast Light Alloy, Harbin, China  
**Plant type.** Hot rolling mill  
**Our solution.** Twin Coiler finishing mill  
**Technical data.** Width 900 - 1,850 mm; thickness 2.5 - 18.0 mm  
**The result.** Production of 210,000 t/a of high quality hot rolled strip from 2012



### UP TO A QUARTER-MILLION TONNES - RIGHT FROM THE START

**Customer.** SouthWest Aluminium, Chongqing, China  
**Plant type.** Cold rolling mill  
**Our solution.** 4-high breakdown mill with DSR®  
**Technical data.** Width 800 - 1,800 mm; thickness 0.15 - 6.0 mm  
**The result.** Production of 250,000 t/a of high-quality cold-rolled strip from 2009



### SPEEDING INTO THE FUTURE

**Customer.** CBA, Sorocaba, Brazil  
**Plant type.** Cold rolling mill  
**Our solution.** 4-high breakdown mill with DSR®  
**Technical data.** Width 1,000 - 2,100 mm; thickness 0.075 - 4.0 mm  
**The result.** Production of 50,000 t/a of high quality cold rolled strip from 2010



**A QUANTUM LEAP IN QUALITY**

**Customer.** Huta Konin, Konin, Poland  
**Plant type.** Cold rolling mill  
**Our solution.** 4-high thin-strip mill with VC roll  
**Technical data.** Width 900 - 1,650 mm; thickness 0.04 - 1.5 mm  
**The result.** Production of 40,000 t/a of high-quality cold-rolled strip since 2006



**FOILS FOR THE FUTURE**

**Customer.** Shanghai Shenhua, Shanghai, China  
**Plant type.** Foil rolling mill  
**Our solution.** Foil roughing mill, foil intermediate mill, foil finishing mill, all with VC rolls  
**Technical data.** Width 1,000 - 1,920 mm; thickness 0.006 - 0.6 mm  
**The result.** Production of 25,000 t/a of high-quality foil since 2006



**MOVING THE ALUMINIUM INDUSTRY IN CHINA**

**Customer.** Alcoa Bohai, Qinhuangdao, China  
**Plant type.** Mill modernization  
**Our solution.** Relocation and upgrade comprising a 4-high roughing mill and a 3-stand tandem finishing mill  
**Technical data.** Width 1,016 - 2,023 mm; thickness 2.0 - 8.0 mm  
**The result.** Production of 150,000 t/a of high-quality hot-rolled strip from 2008



**RAZOR-SHARP PRECISION**

**Customer.** Novelis Packaging, Bridgnorth, United Kingdom  
**Plant type.** Mill modernization  
**Our solution.** Extensive upgrade of a 4-high foil finishing mill  
**Technical data.** Width 825 - 1,650 mm; thickness 0.0055 - 0.76 mm  
**The result.** Production of 12,000 t/a of high-quality foil since 2003



**Customer.** Chinalco Henan (Henan Zhongfu), China  
**Type.** Cold Rolling Mill  
**Our Solution.** 4-High breakdown mill with DSR  
**Technical Data.** Width, 900 - 2,100 mm, thickness 5.5 mm - 010 mm  
**The result.** High speed rolling up to 1800m/min, 120,000 tpy production capacity



**Customer.** Aleris - Dingsheng, Zhenjiang, China  
**Plant Type.** 4.0m Plate Mill  
**Our Solution.** Single Stand Plate Mill  
**Technical Data.** Width 1,070 - 3,800mm, Thickness 6-250mm  
**The Result.** 250,000 tonnes per annum of heat treated and non-heat treated sheets and plates



**Customer.** Novelis Korea, Ulsan  
**Plant Type.** 3-stand Hot Mill  
**Our solution.** 3 Stand hot finishing mill, expansion to existing single stand twin coiler hot mill to increase throughput  
**Technical Data.** Width 2200 mm (untrimmed - 2150 mm (trimmed), Entry thickness 60 mm - 25 mm, Exit thickness 6 mm - 25 mm  
**The result.** Improved product quality and mill throughput.



**Primetals Technologies Limited**

A joint venture of Mitsubishi Heavy Industries and partners

Sheffield Business Park  
Europa Link | Sheffield, S9 1XU  
United Kingdom

[primetals.com](https://www.primetals.com)

Brochure No.: T07-0-N023-L4-P-V3-EN

Printed in Austria

© 2020 Primetals Technologies Ltd. All rights reserved

The information (including, e.g., figures and numbers) provided in this document contains merely general descriptions or characteristics of performance based on estimates and assumptions which have not been verified.

It is no representation, does not constitute and/or evidence a contract or an offer to enter into a contract to any extent and is not binding upon the parties. Any obligation to provide and/or demonstrate respective characteristics shall only exist if expressly agreed in the terms of the contract.

These estimates and assumptions have to be analyzed on a case-to-case basis and might change as a result of further product development.

Primetals Technologies excludes any liability whatsoever under or in connection with any provided information, estimates and assumptions. The provided information, estimates and assumptions shall be without prejudice to any possible future offer and/or contract.

Any use of information provided by Primetals Technologies to the recipient shall be subject to applicable confidentiality obligations and for the own convenience of and of the sole risk of the recipient.

Primetals is a trademark of Primetals Technologies Ltd.