



SOLUTIONS FOR BLAST FURNACES
PROCESS AND COST OPTIMIZATION
FROM A SINGLE SOURCE

YOUR CHALLENGE

RELIABLE, ECONOMIC AND ENVIRONMENTALLY COMPATIBLE HOT METAL PRODUCTION

FULFILL GROWING MARKET REQUIREMENTS

In a rapidly changing economic climate, you need a technology partner that can meet your changing needs. Key challenges facing blast furnace operators include maximizing production from both new and existing blast furnace capacity, assuring a continuous and reliable supply of hot metal for the steel plant, and achieving uniform quality at the lowest-possible costs.

PLANT CAPACITY

Major growth in integrated plant capacity, particularly in emerging markets, means that excess capacity remains the biggest threat to the steel sector. In 2013, utilization was approximately 80%. That figure is being felt today in lower demand for new major capital plant projects, despite the fact that around half of the installed capacity requires major repairs, rebuild or replacement of key plant components such as hot blast systems.

AN INVESTMENT IN THE FUTURE

As a steel producer, your success is determined by costs, quality and the flexibility to meet rapidly changing market demands. Therefore, new plants and modernizations have to meet requirements in regard to performance and support increased productivity. Reliable automation systems and equipment are important tools to minimize operator intervention and thereby increase personnel safety. To satisfy ever-stringent environmental legislation, it is paramount to continuously lower plant emissions. In addition, operators have to find ways to reduce maintenance yet still maintain higher levels of availability. When it comes to replacing or repairing a plant, the shortest project timescales are key for minimizing loss of output. As such, rapid start-up and achievement of high productivity call for advanced technology and proven solutions - both of which are essential for long campaign life and sustainable blast furnace operation.





YOU EXPECT ...

- Low-cost input feeds that meet required hot metal production and quality targets
- Well-engineered equipment and refractories to minimize production downtime and maximize campaign life
- Reduced emissions below the legislative limits while realizing fuel-efficient operation
- Immediate and long-term service for the entire lifecycle of your investments
- Advanced control and automation systems to ensure safe and stable process conditions while minimizing operator intervention

Primetals Technologies offers unparalleled experience in the design and supply of blast furnaces with a unique capability to rebuild stoves of any type and from any supplier.

OUR SOLUTION

FULLY OPTIMIZED HOT METAL PRODUCTION

TOTAL SOLUTION COMPETENCE FOR THE BLAST FURNACE INDUSTRY

Primetals Technologies is the leading supplier of blast furnace technology. Our engineering excellence and expertise gained in delivering proven know-how has served our customers all over the globe for over a century. We fully understand your requirements, and with over 185 plants supplied worldwide to date we have the background and experience to meet your specific needs. Whether the scope is capital builds, enhancements to an existing plant or the supply of individual equipment, our customers benefit from our dedicated project management and execution, shorter project timescales, rapid start-ups and production optimization. Primetals Technologies offers the complete portfolio of technology to meet the highest demands in regard to performance, reliability, environmental impact and cost effectiveness. Through our global presence and comprehensive after-sales network, we are your complete lifecycle partner.

RELIABILITY THROUGH ENGINEERING AND DESIGN EXCELLENCE

Blast furnace operational excellence begins with the design. A fully optimized, freestanding, thin-shell and sound structure is installed to withstand stress and cracking, even toward the end of a furnace campaign. The water-cooling system, cooling elements and heat-monitoring systems are all fully optimized to ensure a long furnace shell lifetime and minimal maintenance requirements. Operator safety is enhanced with a flat, virtually obstacle-free casthouse floor and by sensitive emission-control systems.

Raw materials can be accurately and flexibly charged onto the top surface of the blast furnace burden, promoting a uniform gas flow and ideal smelting-reduction conditions. In combination with the Primetals Technologies process automation and optimization system, which includes numerous process models and an expert system, lower-cost raw materials can be used and coke consumption thereby substantially reduced. The result is major savings in blast furnace operation.

ENVIRONMENTAL COMPATIBILITY

Efficient, clean-burning stove technologies ensure a reliable supply of hot blast to the furnace. Furthermore, total environmental compliance is achieved with the latest developments in gas cleaning technologies. With these solutions, dust separation efficiency can be flexibly adjusted to maximize dust recycling to the blast furnace and hence iron recovery. At the same time, the quantity of residues that must be treated and dumped can be efficiently reduced. With Primetals Technologies' proprietary slag-granulation system, cement-quality slag is produced that can be profitably sold on the market.

PROFIT FROM EXPERIENCE

Well-engineered plants are the basis for long-term successful and profitable operations. We have the complete range of solutions and systems to meet all requirements of the blast furnace. Profit from the experience of the world's leading supplier of blast furnace technology.

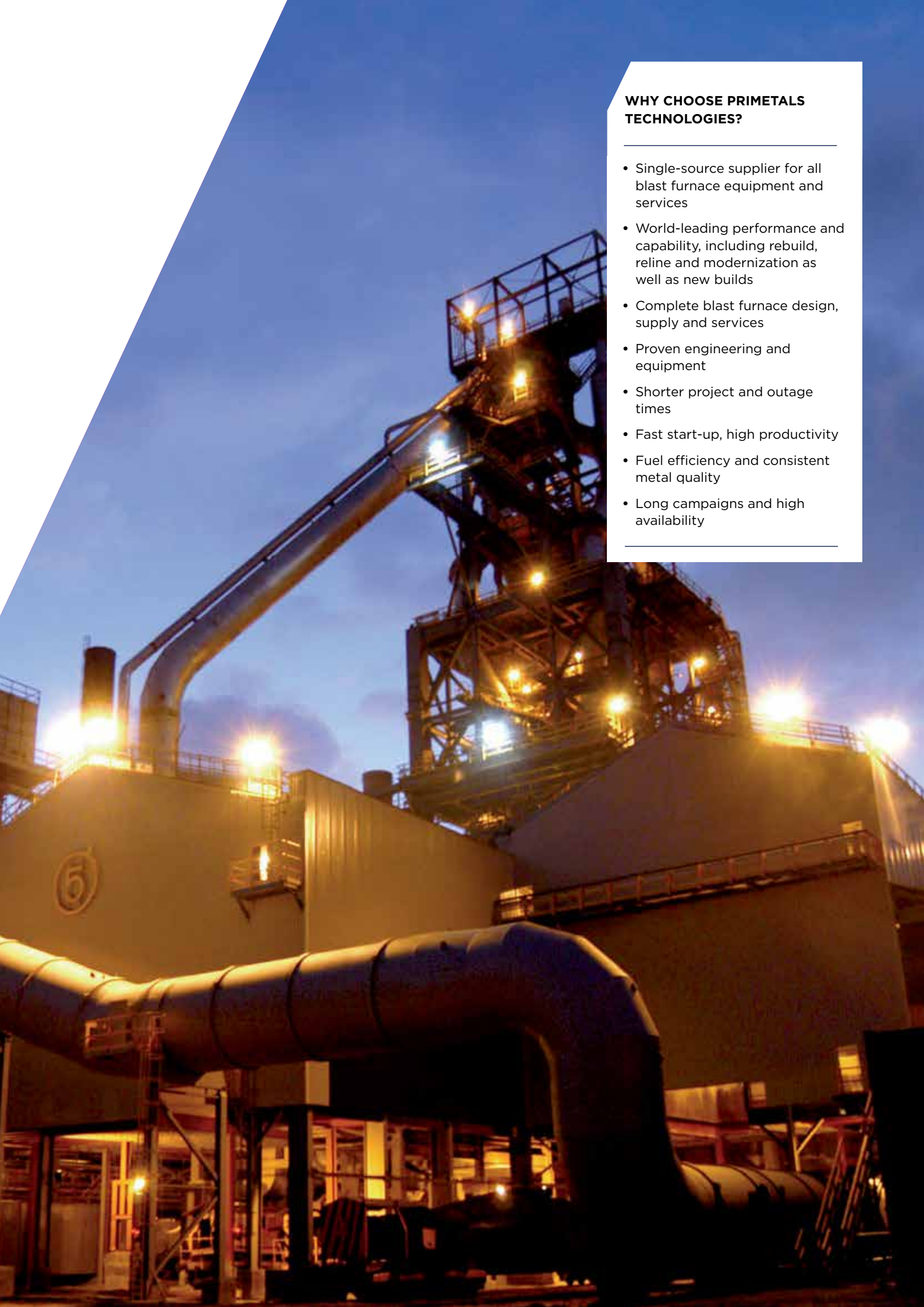

WHY CHOOSE PRIMETALS TECHNOLOGIES?

- Single-source supplier for all blast furnace equipment and services
 - World-leading performance and capability, including rebuild, reline and modernization as well as new builds
 - Complete blast furnace design, supply and services
 - Proven engineering and equipment
 - Shorter project and outage times
 - Fast start-up, high productivity
 - Fuel efficiency and consistent metal quality
 - Long campaigns and high availability
-

BLAST FURNACE DESIGN FEATURES



Companhia Siderúrgica de Tubarão (CST) Brazil, Blast Furnace No. 3



Tata Steel Ltd, Port Talbot, Blast Furnace No. 5

CONSISTENT AND RELIABLE IRONMAKING

Solutions incorporating the latest process, mechanical and automation developments enable you to reliably produce the highest-quality hot metal at the lowest-possible price. An overview of the Primetals Technologies portfolio of furnace equipment and services:

- Proven engineering for all equipment
- High productivity and fuel efficiency
- World-class availability
- Ultra-long campaign lifetime of over 20 years
- Fast and reliable start-up to production levels
- Consistent production of high-quality iron
- Lowest-possible maintenance requirements

REBUILDS, RELINES AND MODERNIZATIONS – FROM THE FOUNDATION TO THE BLEEDER VALVES

Primetals Technologies is renowned for its ability to execute rebuilds, relines and modernizations within extremely tight time frames by incorporating unique execution approaches:

- Freestanding furnace shell design within the existing tower structure or the complete furnace and tower structure
- Revised furnace profiles and cooling concepts to realize a corresponding increase in the working volume of the furnace and hence operating capacity
- Modular construction philosophies minimize project duration and plant downtime. Site areas can be designed to allow for pre-assembly of multiple furnace stacks and tower modules. Module size can be optimized and pre-assembled and tested, complete with stairs, walkways and all pipe mains
- Simultaneous, multi-module working at the ground level with multi-discipline working, e.g., structural, piping and electrical at the same time, leads to a reduction of non-productive time. A just-in-time philosophy across multiple work fronts is generally adopted
- Mobile platform utilization reduces scaffolding yet still allows good access, resulting in safe working conditions with the corresponding quality benefits and costs advantages
- Rigorous quality standards are monitored throughout the assembly period
- Integration of new automation into existing control systems during or prior to the main repair period



Transport to Tata Steel in Port Talbot, UK



Companhia Siderúrgica Nacional (CSN), Brazil

FOCUS TECHNOLOGY AREAS

In order to optimize your investment planning and operational flexibility, Primetals Technologies has developed world-leading solutions to deliver major improvements in rebuilds, relines and modernizations:

- State-of-the-art stove-cooled stack linings with intensive furnace stack monitoring systems
- Increased hearth volume and taphole-to-tuyere distances
- Hot blast stove replacement or repair with options for technologies to optimize efficiency
- Dry and wet gas cleaning for state-of-the-art environmental performance
- Casthouse and casthouse equipment to provide reliable, safe and flexible operations
- Furnace top-charging systems, fuel injection and integration to material feed control philosophy
- Improved automation and control systems (level 1, 2 or expert system) to complement technological enhancements



BUILT FOR OPTIMUM PERFORMANCE

BLAST FURNACE DESIGN FEATURES



- 1 Freestanding access tower
- 2 Top ignition lance
- 3 Above-burden probe
- 4 Stave or plate coolers
- 5 Hot blast system
- 6 Sub-burden probe
- 7 Throat armor and staves
- 8 Furnace top-charging system
- 9 Gas uptakes
- 10 Bleeder valves

GENERAL

- Freestanding shell and tower
- Comprehensive stress distribution assessment of the shell
- Optimized access

THROAT ARMOR AND STAVES

- Heavy-duty armor castings
- Replaceable front plates
- Cast-iron staves with independent cooling
- Staves maintain furnace profile throughout the campaign

STAVE COOLING

- Robust integral linings provide intensive stave piping over the furnace height
- Copper staves in high-heat flux zones
- Cast-iron staves for lower-cost solutions

REFRACTORIES

- Erosion-resistant alumina in upper stack
- Silicon carbide in bosh and belly
- Erosion-resistant carbon hearth walls with ceramic pad

COOLING PLATE OPTIONS

- Intensive plate density over furnace height, welded for sealing efficiency
- High heat transfer via multi-path coolers
- Optimized water requirements

FURNACE ANCILLARIES

- Taphole equipment
- Furnace instrumentation
- Hot metal and slag handling systems
- Casthouse dedusting

FUEL INJECTION

- Coal, gas and oil injection

PROCESS CONTROL

- Furnace condition monitoring
- Heat and mass balance models
- Burden and hearth wear models
- Online kinetic process models
- Expert closed-loop control

HOT BLAST SYSTEM

- Waste-heat recovery
- Stove oxygen enrichment
- Flue gas recycling
- False air

TOTAL BLAST FURNACE COMPETENCE

SERVICES AVAILABLE TO PRIMETALS TECHNOLOGIES CUSTOMERS

CONSULTANCY

Reliable equipment is a result of sound design, fitness-for-purpose concepts and safety features, coupled with mechanisms to fulfill environmental and operability demands. Key design tools to optimize solutions include finite element stress analysis and computational fluid dynamics. Legislation in regard to owner responsibility is becoming increasingly stringent. To adhere to the law, you need the best advice possible on your plant design. In the Eurozone and beyond, owners and operators must demonstrate compliance with the current European safety regulations as they apply to blast furnace technology. Plants that adhere to these design guidelines also have world-class safety features.

Executing design assessments requires extensive experience in the following areas:

- SHEP/HAZOP studies
- Hazardous area classification
- Safety integrity level assessments
- Pressure equipment and machinery
- Compliance with equipment directives

CE marking and compliance certification demonstrate your willingness as an operator to meet some of the most demanding safety design parameters globally. As a consequence, you benefit from the impacts on operations and equipment, and personnel safety is increased.

PLANT COMMISSIONING

Primetals Technologies has a long and successful history of commissioning both new and rebuilt blast furnaces, whether the design is from Primetals Technologies or a third party. Activities include management, programming and commissioning activities to successfully bring your blast furnace into rapid production. During the blow-in period, Primetals Technologies can provide advice in regard to dry out, leak testing and filling the furnace. To prepare the furnace for a shutdown period or for rebuild or reline activities, Primetals Technologies also provides services for the blowing down, salamander tapping and quenching operations.

INVESTIGATION AND STUDY WORK

In the event of plant failures or with a view to optimize plant operations, Primetals Technologies can undertake small or larger-scale studies. On the basis of their extensive technical and operational experience, Primetals Technologies engineers provide you with short- or long-term solutions, which can also serve as the basis for future investment planning.

Topics typically covered:

- Rebuild/reline scoping
- Performance assessment of hot blast stoves with a view to realizing improved performance
- Investigation of the effects of excessive corrosion/erosion on stresses in pressure vessel systems
- Design studies for equipment that has suffered thermally induced distortion/cracking leading to excessive levels of maintenance activity

To enhance the long-term performance of your plant, technology development studies can include but are not limited to:

- Lifetime assessment of existing blast furnace hearth and advisory services for campaign extensions
- Thermal assessment of copper cooling staves and solutions to combat bending and wear issues in copper staves
- Mass and energy balance for furnace operations

Engineering repairs can be developed and installed to return your plant to its former operational status and minimize production losses. Repairs are proposed and undertaken, drawing on our extensive knowledge.

Primetals Technologies specializes in the coordination of multidisciplinary engineering teams. In fact, we have access to over 100 specialist organizations that operate in diverse engineering disciplines across the globe. We are a member of the Welding Institute and the British Ceramics Research Association. As such, we benefit from the latest innovations in construction and materials research, and this knowledge is integrated into your furnace design.

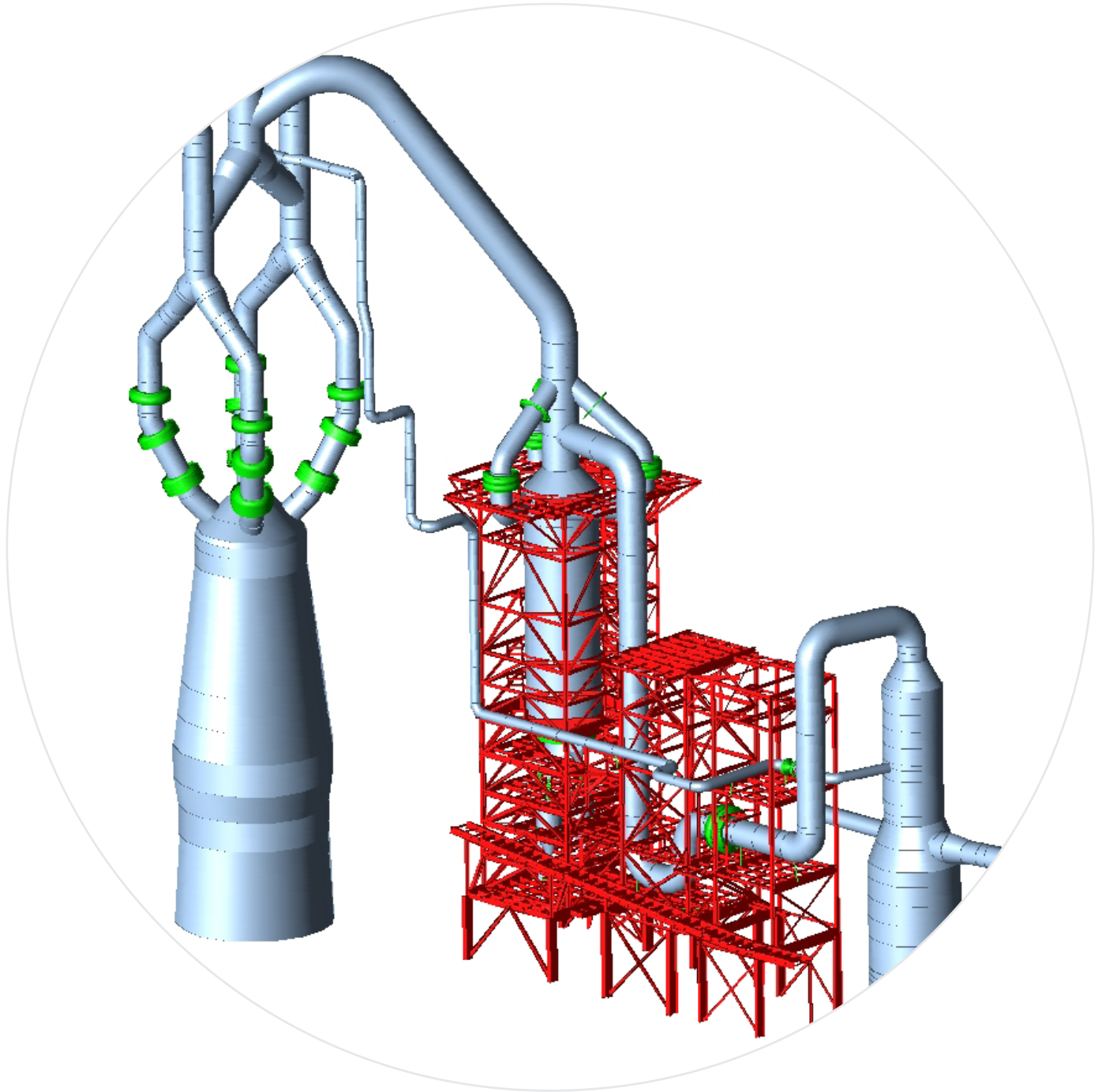

HOT BLAST SYSTEMS AND REFRACTORIES



RELIABLE, POWERFUL AND EFFICIENT

Whether you are installing new equipment or upgrading an existing plant, without a reliable hot blast the furnace will not meet its production potential or your expectations. The refractories form the heart of a stove and must operate in a trouble-free manner for several blast furnace campaigns. Primetals Technologies leads the way in design and supply of complete hot blast stove systems. Designs and refractory considerations are state-of-the-art for stoves, mains, mixing chambers (vertical pot or radial), tuyeres and water-cooled valves. Both internal and external combustion chamber stoves are offered. Both types feature a high-efficiency ceramic burner, while maintaining world-leading environmental performance for CO, SO and NO_x emissions. In addition, supplementary fuel-saving technologies can offer further enhancement. Installations can be undertaken on a turnkey basis.

INTERNAL COMBUSTION CHAMBER STOVES

An internal combustion chamber is an economical alternative to a more complex external combustion chamber design. The internal combustion chamber has a maximum dome temperature of 1,450°C with a SLBT [straight-line blast temperature] of up to 1,250°C. The mushroom dome expands independently of the ring walls. Fully dividing ceramic panel walls eliminate gas leakage. References for this design with over 20 years of continuous service are available.

EXTERNAL COMBUSTION CHAMBER STOVES

Particularly suitable for ultra-high-temperature operation at high blast volumes, external combustion chamber stoves feature a maximum dome temperature of 1,450°C with a SLBT of up to 1,250°C.

COMMON FEATURES

High-efficiency ceramic burner:

Mixing efficiency can meet and exceed the most stringent emissions limits.

Chequers:

A thin wall design optimizes wall thickness, hole size and ease of manufacture. The smallest-possible stove size features unrivalled performance for a wide range of operating conditions.

STOVE REBUILDS

Primetals Technologies offers unparalleled experience in design and supply with a unique capability to rebuild stoves of any type and from any supplier.

Innovative approach to stove rebuilds:

Capabilities include hot repairs or replacement of ceramic burner while maintaining the stove temperature and resulting in minimal disruption to operations. Other services include the “double skinning” of stove shell to overcome the issues with stress corrosion cracking.

Primetals Technologies offers additional technologies to enhance hot blast stove efficiency:

Waste-heat recovery
Flue gas recycling (synthetic air systems)
Stove oxygen enrichment



STOVE /REFRACTORY SERVICES

From design to supply and maintenance, Primetals Technologies is involved in the entire product lifecycle of your hot blast stove. Services include:

- Investigation and reporting:
- Primetals Technologies
- determines the condition of your existing installation, including hot, internal visual inspection.
- Plan future maintenance or correction work: We can help facilitate your hot blast stove outages to maintain current operations or to minimize stoppages where these are inevitable.
- Supply and inspection of new refractories: Refractory supply and full inspection according to ISO standards.

Trusted, audited refractory suppliers ensure material quality. Installation Refractory designs have been developed that allow a rapid installation with a minimum of site cuts. Refractory work is supervised by experienced personnel to ensure high standards are always maintained. Dry-out, warm-up and commissioning stove heat is critical and carefully controlled over a number of days to prevent thermal stress damage to your refractories. Confidence in stove operations results from an experienced installation and commissioning team undertaking your restart activities in line with sound procedures and extensive testing regimes

SAFE, DURABLE, MODERN AND ECONOMICAL FURNACE REFRACTORIES

The choice of refractories and cooling systems at each zone of your blast furnace is critical for success in regard to economic considerations and above all for safe ironmaking operations. Primetals Technologies refractory designs have been developed for over a century and boast long, high-productivity campaigns.

The latest designs and materials are applied in an integrated approach considering:

Campaign life

Blast furnace hearth refractories can determine the campaign life of a furnace. Correct design, material selection and specification, and inspection and installation are critical to a safe, trouble-free hearth. Innovative methods of construction not only save downtime but also ensure a rapid start-up when complete. All furnace refractories are fully designed to adhere to ISO standards. Critical items like hearth carbons and tuyere surrounds are trial assembled. Successful refractory performance requires correct design, materials and installation. Experienced suppliers who are familiar with our refractory design ensure these procedures are correctly followed.

Primetals Technologies' carbon hearth designs are optimized for your requirements in regard to thermal and mechanical resistance.

Micropore & SuperMicropore Carbons

- Ceramic arrestor courses
- Erosion-resistant ceramic cup

The design and supply of refractories for other parts of the ironmaking plant are available, such as:

Tuyere stocks

- Low-maintenance trough and runner systems
- Dirty gas system and gas cleaning plant refractories
- Material-handling systems
- Heat and fire protection

FURNACE COOLING

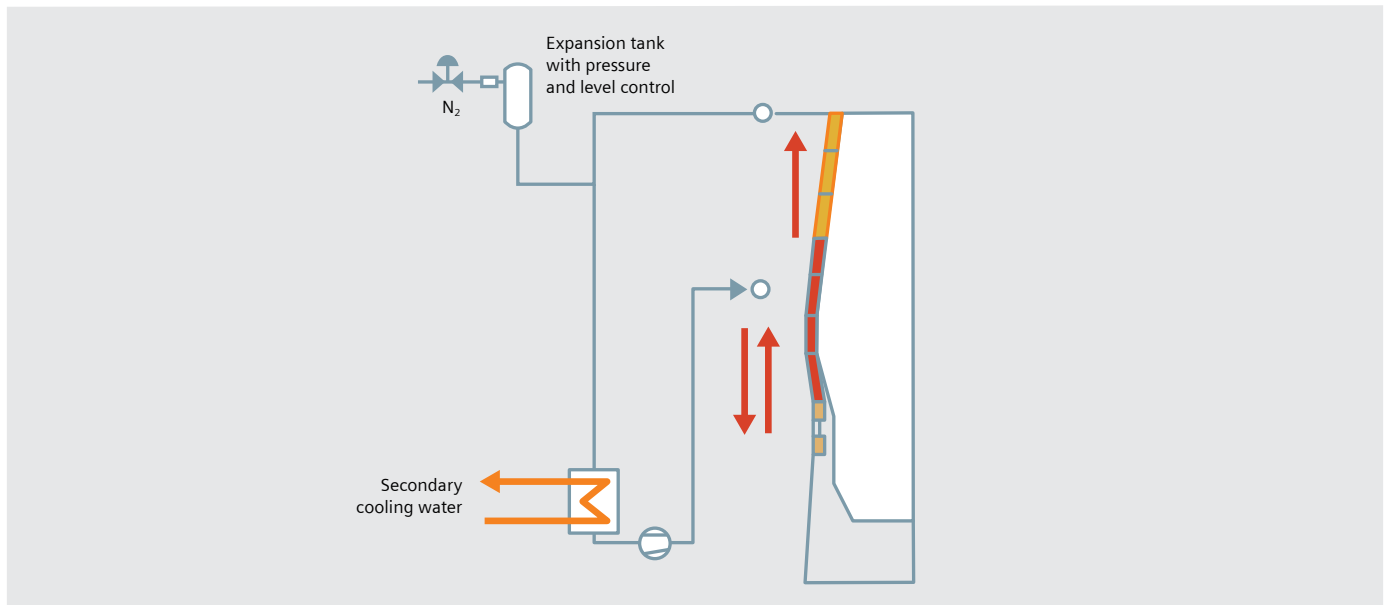

Cooling circuit

EVERLASTING LININGS

Along with the refractory lining, the blast furnace cooling system is critical to ensuring an ultra-long campaign life. Using our extensive experience and knowledge of blast furnace systems, we design furnace cooling circuits that feature advanced control systems, accurate leak detection and emergency back-up systems.

Cooling-water-circuit design is centered upon protecting both the furnace shell and the individual water-cooled elements. Closed-loop pressurized water circuits with forced recirculation and water treatment allow the circuit to operate at the optimum water velocity. This combination ensures efficient cooling and allows the water chemistry to be monitored, therefore resulting in minimal fouling of the water mains. Other advantages of this design are low water and power consumption. Reliable and easily maintainable plate heat exchangers are connected to an efficient secondary cooling circuit.

ECONOMIC AND EFFECTIVE

For the main body of the furnace, stave cooling or, if required, plate cooling options can be supplied. In order to provide the optimum solution, the latest furnace cooling designs utilize both copper and cast-iron staves. The use of staves reduces the requirement for a large quantity of refractory to be utilized in the furnace stack. Also, staves allow the furnace profile to be maintained throughout the campaign. Copper staves are specially designed for use in the high-heat flux zones of the furnace and have been proven to be highly reliable and cost effective.

In recent years and across the globe, a significant number of furnace enhancements have been incorporated into new cooling philosophies for the furnace. Primetals Technologies stave cooling designs have consistently proven their suitability in furnace upgrades, resulting in campaign lives beyond other market providers. This is only possible through the combination of key shell design parameters and appropriate engineering for the integration of the cooling element. In several cases where new installations have failed within very short operational time spans, Primetals Technologies designs have been implemented and tested for extended periods of operation with little or no wear, and no evidence of stressed elements. Production availabilities demanded by the client have been met and, as a result, operators can look forward to providing high-quality products far into the future.

The furnace hearth refractory and cooling system are designed to function together to ensure long life and stable operations.



Primetals Technologies offers several configurations:

- Water-cooling utilizing tubes positioned either above or below the base plate of the furnace
- Hearth-wall cooling through the use of a water shower, jacket or stove cooler

LEAK DETECTION

Accurate leak detection for furnace cooling systems is a critical aspect of successful plant operation and safety. Our closed cooling circuits incorporate an expansion vessel that together with our advanced control philosophy allows accurate monitoring and safe operation of the closed circuit. The limits of detection are ultimately governed by the extent of monitoring instrumentation and vessel design.

MAIN BENEFITS

- Total furnace shell protection
- Maximized furnace working volume
- Minimum cooling element costs
- Low operating and maintenance costs

Cooling staves,
Companhia
Siderúrgica Nacional
(CSN), Volta
Redonda, Brazil



GAS CLEANING

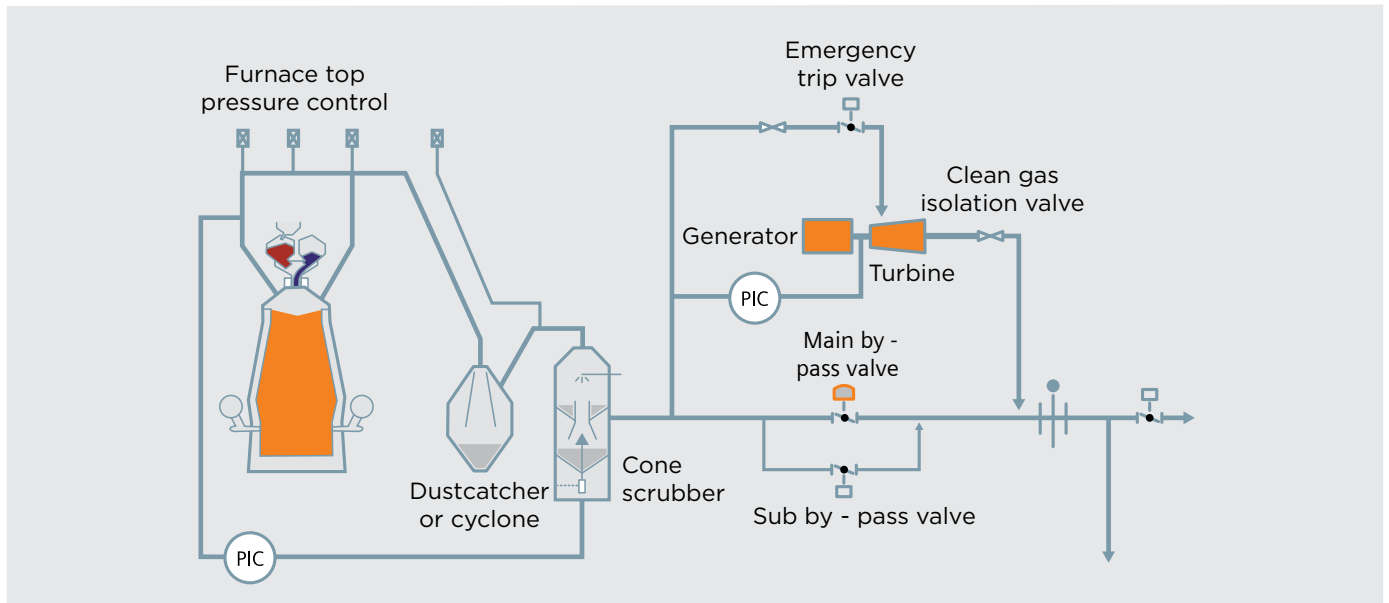

DUST REMOVAL AT ITS FINEST

When considering your gas cleaning requirements, your technology must utilize utilities efficiently, maximize gas energy recovery and meet all environmental regulations. Primetals Technologies has a long and successful history in supplying environmental technologies for plants of all types, for example water treatment, dust recycling, energy recovery, and systems for clean gas distribution.

Projects undertaken range from the supply of new gas cleaning plants, which maximize the collection of dry dust, to the replacement and upgrading of existing equipment to state-of-the-art solutions. The main focus at Primetals Technologies is on simple, robust gas cleaning systems, ideally suited for all blast furnaces, even with high coal injection rates.

MAIN BENEFITS

- Full range of solutions for all gas cleaning requirements
- Optimized dust separation efficiency
- Fulfillment of the strictest environmental emission limitations
- Proven solutions on the basis of decades of experience

PRIMARY GAS CLEANING

Primetals offers designs for dust catchers and cyclones, or a combination of both systems. However, where there is a need to remove higher percentages of dust and to reduce water treatment requirements, the dust catcher can be replaced by a cyclone. This is the case for both new plants and for modernizations.

For the cyclone, Primetals Technologies offers two solutions:

- Single-side entry
- Triple entry, which can replace the top of existing cyclone designs that adopts swirl vanes and are susceptible to blockage or wear

A cyclone optimizes the recycling of blast furnace dusts carried over in the offgas system via higher efficiency separation. Additional benefits can also be realized in zinc carryover control.



SECONDARY GAS CLEANING

Primetals Technologies offers multiple solutions with options for combinations of the washing/gas saturation stage and the furnace pressure control stage:

- The conditioning tower cools and saturates gas, removing a large percentage of dust particles
- The gas scrubber cleans process gas, guaranteeing dust content of less than 5 mg/Nm³ while controlling the furnace pressure to within 1.5% of its set point

Gas scrubbers from Primetals Technologies have been in operation for over 30 years with multiple units utilizing single or triple annular cone devices on furnaces of varying productivity and size. The latest generation of triple-cone designs calls for an external position, away from the main vessel, to facilitate ease of maintenance. The result is reduced vessel size and a demister bed that can be located internally.

All solutions developed for new gas cleaning plants are also ideally suited for retrofitting into existing facilities. In addition, corrosion has become an increasing problem for operators with the higher prevalence of tuyere injectants. Primetals Technologies has developed a cost-effective and robust corrosion protection system based on careful material selection and internal coatings.

Xianghan blast furnace conditioning tower and scrubber





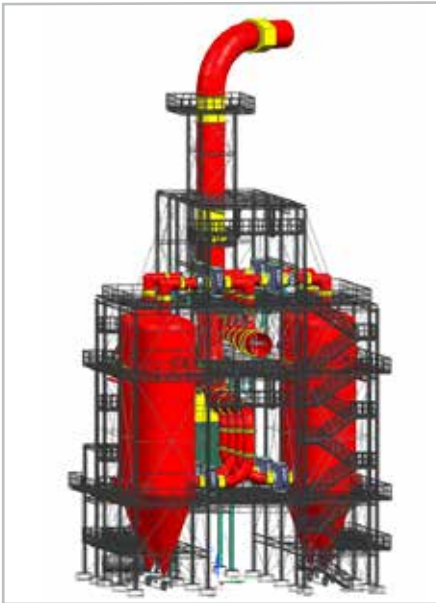

MERIM

Merim, which stands for maximized emission reduction and energy recovery in ironmaking, is an advanced dry gas cleaning technology developed by Primetals Technologies for blast furnaces.

The new system for blast furnace top gas cleaning includes a cyclone for coarse dust separation and a high-performance fabric filter for fine dust removal. In order to solve the problem of temperature fluctuations in the top gas, Primetals Technologies has developed a gas-conditioning concept that allows for safe operation at low and high temperatures alike.

Using this green solution, energy consumption and the amount of waste sent to landfills can be reduced to currently unachieved levels. The cleaned gas meets both current and future emission regulations for a significantly reduced CO₂ footprint.

- No sludge and waste water treatment necessary
- Clean gas concentration of <math><5 \text{ mg/Nm}^3</math> achievable
- 20% to 30% higher energy output from the top gas recovery turbine due to higher process temperatures and lower pressure losses
- Easy reutilization and handling of byproducts
- Lower operating and investment costs compared to wet solutions (e.g., electricity, water)
- Less maintenance and increased availability
- Less space requirements (about 40% to 60% less compared to a complete wet-type installation)
- Advanced emission control (e.g., HCl, H₂S) is possible

CASTHOUSE AND BLAST FURNACE EQUIPMENT

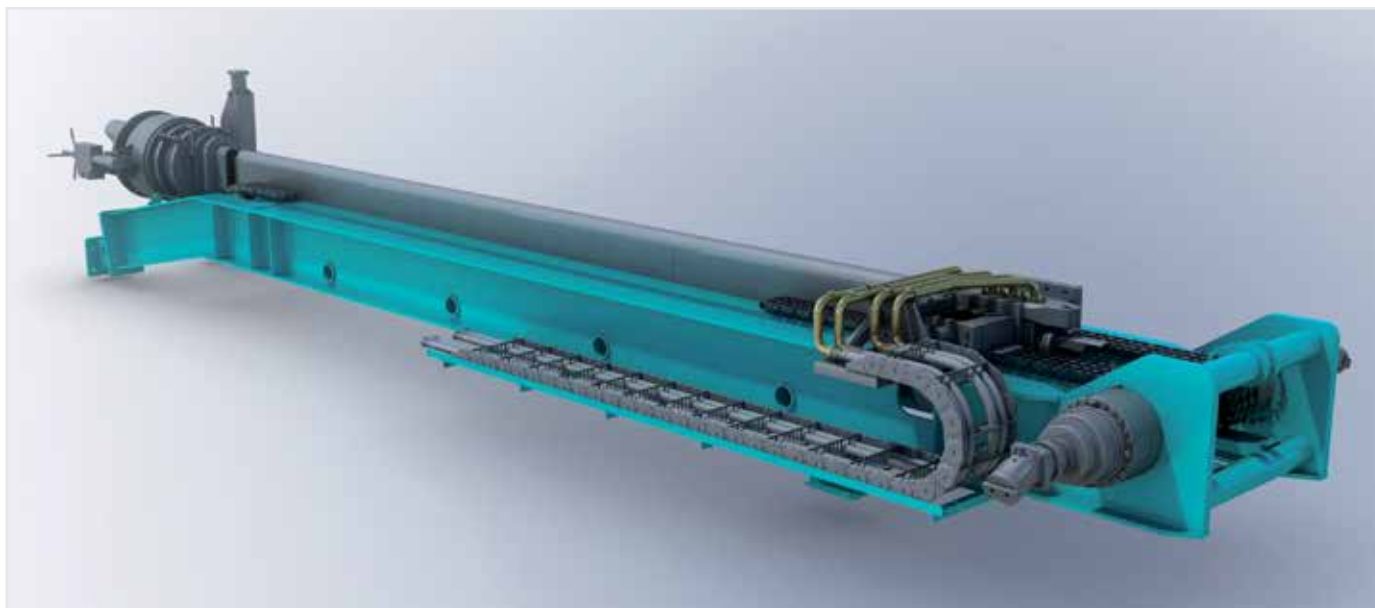

SAFE, RELIABLE AND ENVIRONMENTALLY FRIENDLY CASTHOUSE

As proven at numerous operating blast furnace plants around the world, Primetals Technologies' blast furnace equipment has a reputation for reliability, durability and high performance. Supplied to suit the arduous conditions of the blast furnace environment, equipment is designed and analyzed using the latest stress analysis tools and then built and workshop-tested to the highest standards.

For single to four taphole arrangements, the Primetals Technologies' casthouse is always designed for safe, reliable and environmentally friendly operation. The layout is designed to provide ease of access based on individual site logistics and furnace size. In addition, efficient iron slag separation via optimized runner design and collection in torpedo or ladle cars ensures high-quality iron.

Hot metal weighing and level measurement improve tapping accuracy and furnace control, while environmental performance is enhanced through casthouse fume extraction systems. Multiple configurations are available to match your casting operations, incorporating totally covered runners with hoods integrated into the floor and dedust ducts arranged below the floor. Slag granulation is designed to meet the most stringent environmental standards. To this end, the solution incorporates a full condensation system to prevent the escape of sulfur-bearing steam

CASTHOUSE FEATURES

- Flat floor concept with ramp access for unhindered plant operation
- Minimum maintenance runner design
- Remote operation of casthouse equipment
- Environmental control via dedusting and dust suppression
- Hot metal treatment and slag granulation

CASTHOUSE EQUIPMENT

- Taphole drills and mud guns
- Mud guns
- Tilting runners and machines to remove the trough cover
- Hydraulic clay guns
- Hydraulic or hydro-pneumatic taphole drills
- Trough cover manipulators
- Tilting runners for iron and slag
- Bar changers
- Jack dam drills



BLAST FURNACE EQUIPMENT

For consistent delivery of blast and injectants to your furnace process:

- Tuyere stocks feature state-of-the-art mechanical design
- The tuyere camera system allows operators to safely ascertain tuyere and raceway conditions via a visual imaging system. Pre-empt fault conditions help avoid catastrophic failure and consequential outage downtime

To enhance your material distribution and process modeling capabilities for smoother operation:

- Microwave and mechanical stockline recorders ensure material is charged to your process when required
- Moveable and fixed throat armor allow accurate placement in material charging, and directionality is possible
- A profile meter maps the burden profile across the furnace stockline
- Sub-burden gas probes provide accurate in-material temperature and gas analysis profiling across the upper furnace stack
- Above-burden temperature probes are employed for accurate above-material temperature analysis. Profiling across the furnace throat ensures safety of the furnace process, also during maintenance periods
- Bleeder valves feature a “coffee-pot” design
- Stockline ignition lances for safer furnace top condition at blast furnace stops

For reliable operation of the material charging system, equalizing/ relief valves are installed.



SLAG GRANULATION



State-of-the-art blast furnace slag handling technology is integrated into the granulation system from Primetals Technologies:

SLAG GRANULATION SYSTEMS ARE AVAILABLE IN TWO OPTIONS

- Mechanical type with a screw filter
- Pumping type only

ENVIRONMENTAL PROTECTION

- Self-contained, fully enclosed water systems
- Vapors condensed in a dedicated tower eliminate emissions

CONTINUOUS DEWATERING

- **Mechanical type**
Initial dewatering via hydraulically driven screw conveyor. Dewatering continues at the rotating drum filters. Final dewatering then takes place either in dedicated silos or at a stockpile. The moisture content is reduced to below 12% after only two hours of storage.
- **Pumping type**
Dewatering via dedicated silos prior to the pumping of granulation water back to the process. This system achieves the same moisture content as noted above.

PRODUCT QUALITY

Cement quality product, affected by granulation water quantity, temperature and pressure. The granulating head can be either a fixed design or variable orifice for a constant water-to-slag ratio.

Glassy phase	98%
Product moisture	12%

WATER QUALITY

- High-quality, recirculated water cleaned of fine solids and slag wool by a mesh roll filter
- Improved plant availability and reduced maintenance requirements as the process can operate unhindered by filter blockage

MAIN BENEFITS

- Range of configurations and equipment solutions to meet your slag handling requirements
- High utilization rate
- Environmentally advanced solutions meet all emission limits
- Cement-quality product

DRY SLAG GRANULATION

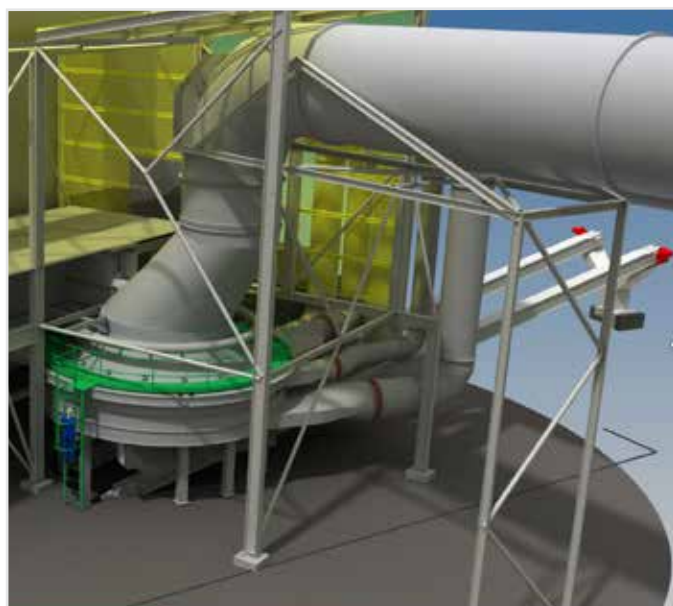
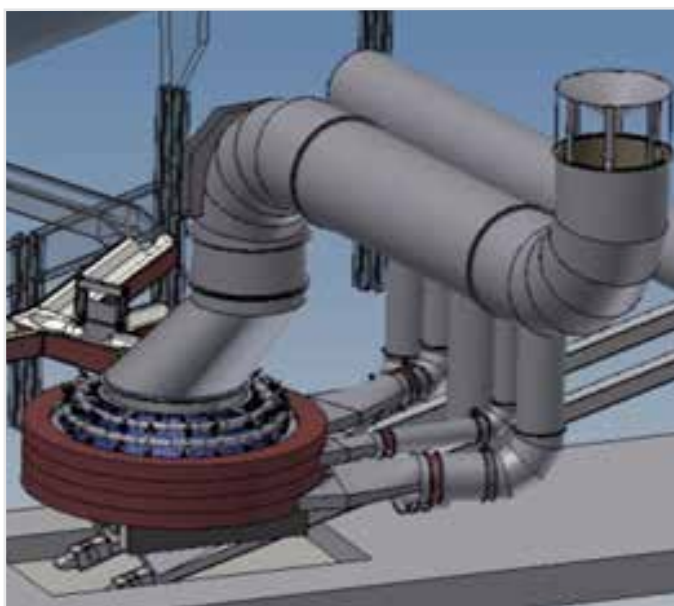

Primetals Technologies is currently far advanced in introducing an innovative new Technology which has the potential to revolutionise how your slag is handled.

CHALLENGE

- Utilize waste heat from blast furnace slag
- Match requirements of cement industry regarding slag product quality

SOLUTION

- Dry granulation of blast furnace slag with rotating cup and air for slag cooling
- Waste-heat recovery solutions to match your requirements
- Steam production for power generation or for heat for other applications
- Industrial-scale pilot plant under development at voestalpine Stahl in Linz, Austria

MAIN FEATURES AND BENEFITS

- Generate steam or electrical power, or utilize the high-temperature heat for other applications
- Recover around 20 MWh or around 6 MW of electricity from a blast furnace slag flow of 1 ton/min
- Produce a dry, valuable, cement-quality slag product
- Reduce sulfur emissions
- Lower a site's carbon footprint
- Water consumption for granulation process is negligible
- There is no interferences with production process

COAL INJECTION



REDUCE COSTS THROUGH COKE REPLACEMENT

To reduce the blast furnace coke rate and to improve furnace operations, complete and well-proven coal injection systems are provided for new and existing blast furnaces. This energy-saving solution is supported by a complete technology/technical support package.

SUPERIOR PROCESS FEATURES

- Coal feedstock screened for tramp material
- Simultaneous crushing and drying in a stream of hot gas or in a combined mill/dryer
- Extraction and sizing
- Bag filter capture
- Final product screening prior to transfer and silo storage
- Efficient, safe operational philosophy:
 - Drying exhaust gases are recycled back to the hot-gas generator at the mill/dryer
 - Low total oxygen content of the hot gas
 - Elimination of potential milled coal ignition

CONTROLLABLE INJECTION - TWO OPTIONS

- Coal flow rate to each tuyere can be independently controlled mechanically for high accuracy
- Splitter-based system for lower accuracy

Availabilities in excess of 98% and accurate coal injection rates to within 2% are typically achieved

ADVANTAGES

- Coal injection rates of over 220 kg/t hot metal
- Exact control of coal injection to individual tuyeres
- Waste-gas recycling to reduce fuel costs
- Major coke rate savings
- Well proven in 20 blast furnace installations
 - Primetals Technologies now has the largest installed coal mill as an operating reference



INNOVATIVE MATERIAL CHARGING



CHUTE-FED SYSTEMS

The modern ironmaking industry is constantly challenged to generate higher productivity while satisfying the challenges posed by ever-tightening operating margins and stricter environmental controls. Primetals Technologies and Wooding's Industrial Corporation have a long history in the iron and steel industry supplying control and automated packaged plants as part of state-of-the-art furnace equipment. In the framework of this longstanding relationship and armed with their extensive experience, Primetals Technologies and Woodings are jointly developing an equipment portfolio of hydraulic material distribution systems.

Since the introduction of no-bell or bell-less tops in the 1970s, it has become an accepted principle that chute-based charging techniques provide the best method of promoting stable, fuel-efficient operation in large-diameter furnaces. As a result, all new furnaces built

in recent years, or even the modernization of existing furnaces, have resulted in the installation of chute-fed top equipment as part of the burden charging/distribution equipment.

Flexible burden distribution control is seen as one of the key tools in the ironmaking process to provide the means to control, influence and improve furnace operation while meeting modern-day operating challenges.

The principle operational efficiencies seen by customers operating chute-fed systems in comparison to bell-fed furnace operations are namely:

- Stabilized blast furnace operation
- Optimized fuel rate
- Higher furnace top pressure operation
- Increased fuel injection rates leading to improved productivity
- Improved material distribution control
- Furnace-wall temperature control for reduced heat loads and extended furnace life

When operating a bell furnace, one of the most significant costs results from the inevitable replacement of both large and small bells, hoppers and receiving hoppers on the furnace top. Each time the furnace is blown down for this type of outage, the ability to return it to full operation is a challenge that can lead to considerable delay and potential further loss of furnace production. The installation of chute-based charging equipment eliminates this routine maintenance regime completely. While the chute needs to be changed more often than bells, the cost of the change and associated routine maintenance is far less than a bell change, or even a seat replacement, and it typically falls within the normal maintenance budget.

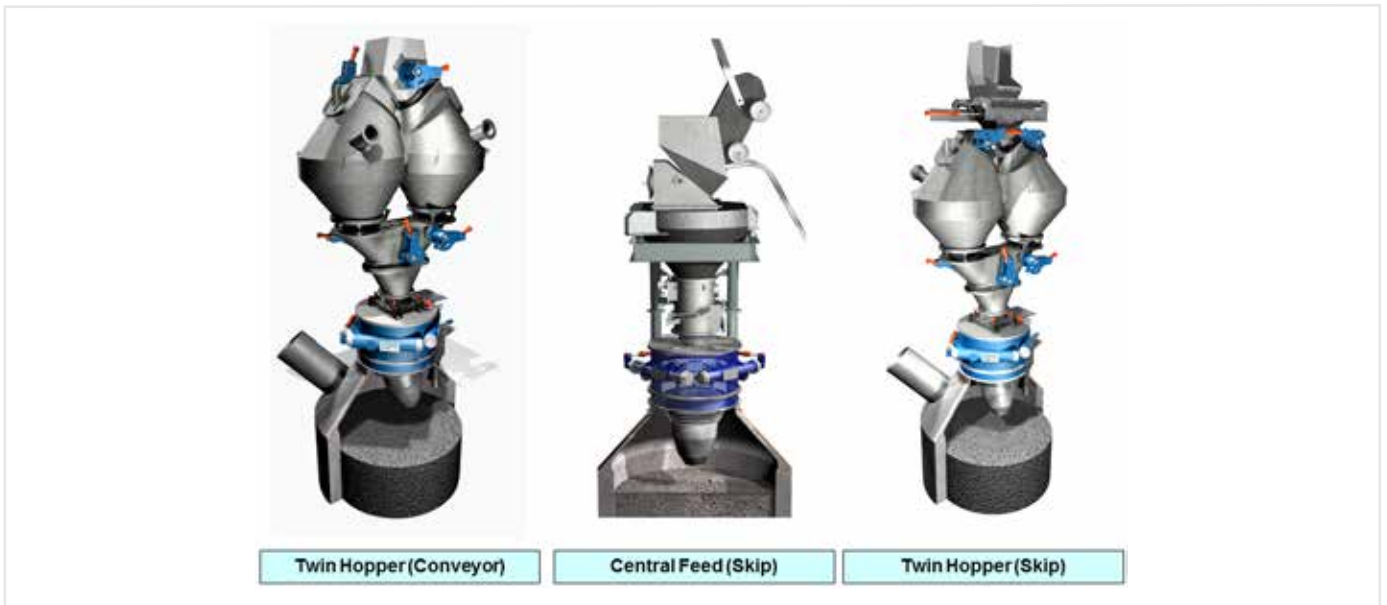

In addition to the benefits achieved from the operational efficiencies, from the outset the aims of any new design when compared to the traditional bell-less top solutions must also provide:

- Interchangeability with existing bell-less top solutions as an upgrade or retrofit
- A simpler design eliminating the complex planetary and vulnerable tilting gearboxes of traditional designs
- Hydraulic drive actuation providing repeatability and accuracy over the entire lifecycle
- Extended time period between required chute replacement periods
- Reduced capex and integration expenditure
- Reduced opex by minimizing unplanned furnace downtime and lowering equipment lifecycle costs

To meet these aims, Primetals Technologies and Woodings Industrial Corporation have a portfolio of hydraulic material distribution systems suitable for small, medium and large blast furnaces worldwide. The portfolio comprises the Woodings Hydraulic Charging Unit (HD) and Gimbal Top, and it incorporates a full complimentary range of furnace top distribution equipment including distribution rockers, upper seal valves, hoppers, lower seal valves, material flow gates and goggle valve assemblies, all discharging through hydraulically driven distribution chutes.

The product range, which has proven its effectiveness in current installations, further improves charging flexibility and process control, enhances blast furnace performance and reduces downtime for scheduled maintenance. After all, avoiding downtime over the course of a year can mean additional production of up to 10,000 tons of hot metal for larger furnaces.



BLAST FURNACE AUTOMATION

DISCOVER THE COMPLEXITY OF THE PROCESS



BLAST FURNACE PROCESS CONTROL

Knowledge and experience accumulated by our specialists combined with innovative technologies are the decisive factors to lift your blast furnace to the next level of automation. Understanding our business as being partner to our clients, we deliver a proven and cost-effective solution from one single source.

We can draw on substantial engineering and operation know-how covering the complete blast furnace lifecycle. Our many years of experience in realizing blast furnace automation projects all over the world enable us to master all upcoming challenges immediately and to the point.

The efficiency of the automation strongly depends on the proper instrumentation. We provide the right instruments at the proper place and fit them seamlessly in our automation solution.

A reliable process control system is the basis for your transition to Industry 4.0. Established and efficient techniques such as server virtualization increase system flexibility and availability and help you to save hardware-, and maintenance costs. The latest industrial Ethernet technologies and proven hardware architecture warrant a maximum performance while keeping the highest IT security levels. Particularly when the technical and strategic course is set to allow a business to efficiently make the move to become a Smart Factory.

The concepts of flexible thinking, bold innovation and intelligent measurements will play an ever more important role in the future to ensure a flexible and trouble-free production.

BLAST FURNACE PROCESS OPTIMIZATION

Blast furnace optimization is an innovative process optimization system that lifts plant automation to a completely new level. Our solution is based on a well-tested and proven basis system which guarantees the highest availability and efficiently combines data-acquisition, -processing and -visualization. Over the last 20 years the system has demonstrated its reliability and cost savings in more than 60 installations all over the world.

A broad spectrum of raw data sources (front-end signals, amount of material charged, laboratory data, events, model results, cost data), is stored over the whole plant lifetime. Specialized tools are provided where process information can be linked to analysis' data and burden matrices. Flexible interfaces, modularization and state-of-the-art software architecture provide the means to easily adapt and maintain the system in an ever changing environment with respect to raw materials, operation philosophy and connectivity to 3rd party systems.

On top of the robust basis system numerous interacting process models support the operators and metallurgical engineers in their daily decisions. Plant specific requirements are incorporated into these metallurgical process models.

End-to-end transparency in real-time through up-to-date data visualization and metallurgical process models lead to better collaboration, improved workflows and reduced errors while supporting decision-making.

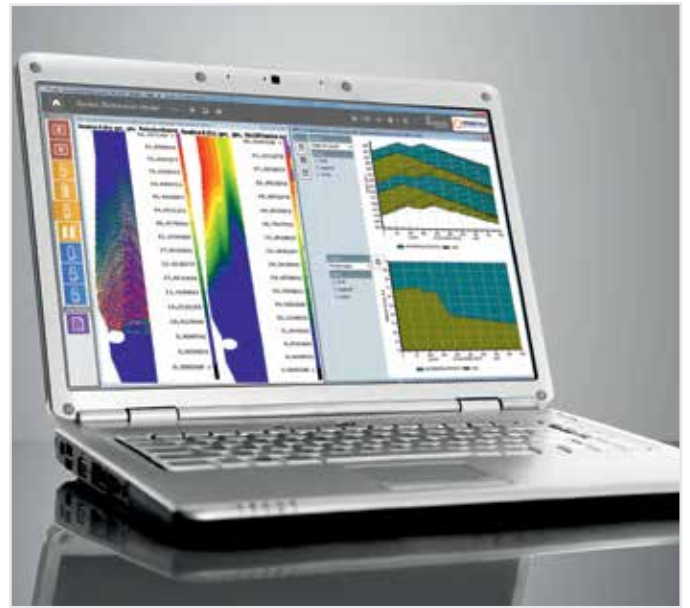
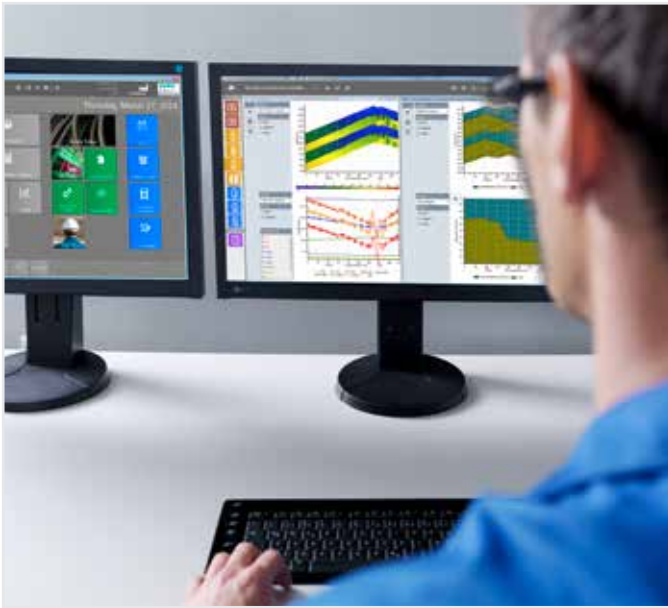

CLOSED-LOOP BLAST FURNACE EXPERT SYSTEM

The closed-loop blast furnace expert system was designed according to the principle 'As few actions as possible, as many as necessary' with the target to enable an optimized blast furnace operation requiring minimal operator interactions.

The expert system - which is designed as a rule based decision system - counteracts process fluctuations caused by changes in the burden composition and quality, human factors or process conditions. The sooner the system responds to an abnormal or changing process situation, the smoother the overall blast furnace operation will be. The accurate timing of control activities and anticipation of disturbances are of utmost importance to avoid critical process conditions and to maintain a high production rate at low costs.

After numerous successful installations Primetals Technologies is in a position to guarantee significant improvements of the product quality and reduction of fuel consumption with the available burden materials.

At shell, we sustainably optimize and control your assets for lifecycle value through the integration of numerous packages to forge a bridge from the intelligent closed-loop controls to a fully automatic product analyzing equipment.

ADVANTAGES OF OUR BLAST FURNACE PROCESS AUTOMATION SOLUTION

- **High productivity**
Keeps the blast furnace running at peak performance while minimizing consumption of electrical energy and fuel
- **Product quality**
Maintains the chemical properties of hot metal and slag at the desired levels
- **Reduced fuel consumption**
Keeps the hot metal's temperature constant through small modifications of the fuel rate, based on the thermal conditions of the blast furnace
- **Stable and shift-independent operation**
Best-practice blast furnace operation 24 hours a day to ensure efficient production
- **Easy integration**
A comprehensive range of metallurgical models and packages that can be easily integrated into any existing automation environment
- **Fast response to market demands**
Enables quick and flexible reactions to market requirements as well as unexpected situations
- **Lifecycle services**
Service and support for upcoming system extensions after startup guarantee sustainable benefits
- **Return on investment**
The standard period is expected to be less than one year

BLAST FURNACE TECHNOLOGY LEGACY



DAVY INTERNATIONAL LTD, 1976

Merger with HW Group Ltd.
YEAR: Redcar Blast Furnace with a 14.0 m hearth blown-in is Europe's largest
YEAR: Acominas, Brazil orders an integrated facility for £250 million

DAVY MCKEE (MINERALS & METALS), 1979

Merger with McKee Corporation, United States

DAVY COMPANY

YEAR: POSCO Kwanyang Blast Furnace No.1, first of 5 blast furnaces

KVAERNER 1996

Kvaerner ASA, Norway, acquires Trafalgar House Engineering

DAVY MCKEE [TRAFALGAR HOUSE] 1991

Davy McKee acquired by Trafalgar House to become an engineering division of Trafalgar House PLC 1990: Clecim of France acquired

PRIMETALS TECHNOLOGIES LTD: OVER A CENTURY OF ENGINEERING IN THE METALS INDUSTRY

Teesside's industrial legacy was forged in the 19th century as a booming center for the growing iron industry. Many aspects were important for this development. One was demand, which was fueled by the first public railway in 1825 from Stockton to Darlington. Another was the extension of communications to nearby coalfields. And naturally, the area was a source of iron ore with major river shipping access and abundant land for the development of industrial complexes. Primetals Technologies owes its location and proud continuation of this tradition to a rich heritage of engineering companies.

EXPERTISE FROM EXPERIENCE



COMPANHIA SIDERÚRGICA DE TUBARÃO (CST), VITORIA, BRAZIL

Blast Furnace No. 3 turnkey plant on a greenfield site



COMPANHIA SIDERÚRGICA NACIONAL (CSN), VOLTA REDONDA, BRAZIL

Turnkey rebuild project for No. 3 Blast Furnace. Shutdown of 98 days to complete a 98.5-day program. Replacement of the shell, cooling system, bustle main, top charging equipment and wet gas cleaning, and refurbishment of the slag granulation system



TATA STEEL LTD, PORT TALBOT NO. 5, UK

Complete rebuild with blow-in less than a year after the contract award - the world's shortest outage for a new blast furnace on an existing foundation. Engineering, procurement, equipment supply and site supervision for construction of freestanding blast furnace and tower, casthouses, cooling systems, skip charging system, refractories and commissioning of all systems



ARCELORMITTAL IH7, EAST CHICAGO, USA

Engineering, procurement and construction management for furnace reline and ancillary equipment enhancements. New cyclone and gas cleaning plant; shell retained with plate to stove conversion. Stove reline required because the furnace shell had suffered severe deformation and the salamander tap revealed mostly frozen hearth. Blow-in achieved in 76 days, two days earlier than schedule



TATA STEEL LTD, PORT TALBOT NO.4, UK

EPCM rebuild of furnace, bustle main and tuyere stock offtakes, downcomers, cyclone inlet isolation, dirty gas main, U-seal and goggle valve, cyclone and gas cleaning plant, furnace cooling systems and associated instrumentation



DRAGON STEEL CORPORATION BF1/2, TAICHUNG, TAIWAN

Engineering, procurement, equipment supply and site supervision for two new copper-stave-cooled blast furnaces and associated ancillary plant. Features included supply of electric blowers, external combustion chamber stoves, gas cleaning with TRT and a 100,000 m³ gasholder



VIZAG NO.1 FURNACE, VIZAKHAPATNAM, INDIA

Turnkey capital repair. Design, engineering and supply. Features: circular casthouse, thin-stave technology





Primetals Technologies Austria GmbH

A joint venture of Mitsubishi Heavy Industries and partners

Turmstrasse 44
4031 Linz
Austria

primetals.com

Brochure No.: T01-O-N101-L4-P-V3_EN

Printed in Austria

© 2020 Primetals Technologies Ltd. All rights reserved

The information (including, e.g., figures and numbers) provided in this document contains merely general descriptions or characteristics of performance based on estimates and assumptions which have not been verified.

It is no representation, does not constitute and/or evidence a contract or an offer to enter into a contract to any extent and is not binding upon the parties. Any obligation to provide and/or demonstrate respective characteristics shall only exist if expressly agreed in the terms of the contract.

These estimates and assumptions have to be analyzed on a case-to-case basis and might change as a result of further product development.

Primetals Technologies excludes any liability whatsoever under or in connection with any provided information, estimates and assumptions. The provided information, estimates and assumptions shall be without prejudice to any possible future offer and/or contract.

Any use of information provided by Primetals Technologies to the recipient shall be subject to applicable confidentiality obligations and for the own convenience of and of the sole risk of the recipient.

Primetals is a trademark of Primetals Technologies Ltd.