



**ECO SOLUTIONS -
SAVING RESOURCES, CREATING VALUE**
A COMPREHENSIVE RANGE OF
FUTURE ORIENTED ENVIRONMENTAL
SOLUTIONS FOR STEELMAKING PLANTS

ECO SOLUTIONS

SAVING RESOURCES, CREATING VALUE

As a result of increasingly stringent environmental regulations and the need to save resources and reduce energy consumption, environmental protection has become more important than ever.

ECO Solutions from Primetals Technologies stands for a wide range of services and advanced technologies that minimize the environmental impact of steel production, improve energy efficiency and optimize by-product management. Primetals Technologies offers expert consulting services, advanced processes and holistic solutions along the entire iron and steel production chain that ensure strict adherence to the emission regulations and support producers to achieve substantial cost savings. The objective is always twofold: to save resources and to create value.

ECO SOLUTIONS

Saving resources

- Optimized use of raw materials
- Reduced energy consumption
- Significant reduction in particulate and gaseous emissions
- Efficient by-product treatment and recycling

Creating value

- Improved plant performance
- Lower conversion costs
- Reduced environmental taxes and disposal costs
- Increased energy recovery
- Substantially improved working conditions and safety

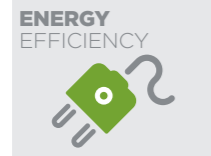

ENVIRONMENTALLY ORIENTED PRODUCTION AND LOWER ENERGY CONSUMPTION

For every metric ton of steel produced, 50 to 100 kilograms of sludge and scale accumulate and approximately 20,000 MJ of energy are consumed. There is no question that modern dedusting systems in combination with energy-recovery technologies and by-product recycling are crucial. However, the outlay for such technology should be no higher than absolutely necessary. The most important goals are high reliability, strict compliance with defined threshold values, and minimum energy consumption and maximum by-product recycling.

Primetals Technologies offers the entire spectrum of gas cleaning and energy efficiency technologies as well as by-product treatment plants from a single source, always in close collaboration with your company's iron and steel production specialists. This is our approach for creating perfectly coordinated and economically viable solutions.

YOU EXPECT

- Cost-efficient production and maximized productivity
- Low consumption levels for energy and utilities
- Maximum energy recovery
- Short delivery times and consistently high availability
- Solid production quality and expert solutions
- Designs that meet future environmental and market requirements at the lowest investment
- A reliable partner with innovative, tailor-made solutions

ADVANTAGES OF PRIMETALS TECHNOLOGIES ECO SOLUTIONS

- Full compliance with agreed-upon limit values
- Tailored ECO plants using comprehensive expertise
- Future emission requirements already considered in the plant layout and design
- More than 40 years of experience and profound knowledge in environmental technologies

ECO SOLUTIONS FOR STEELMAKING

- 1 Gas cleaning
- 2 Energy recovery
- 3 By-product recycling
- 4 Electrics and automation
- 5 Lifecycle services
- 6 Selected references

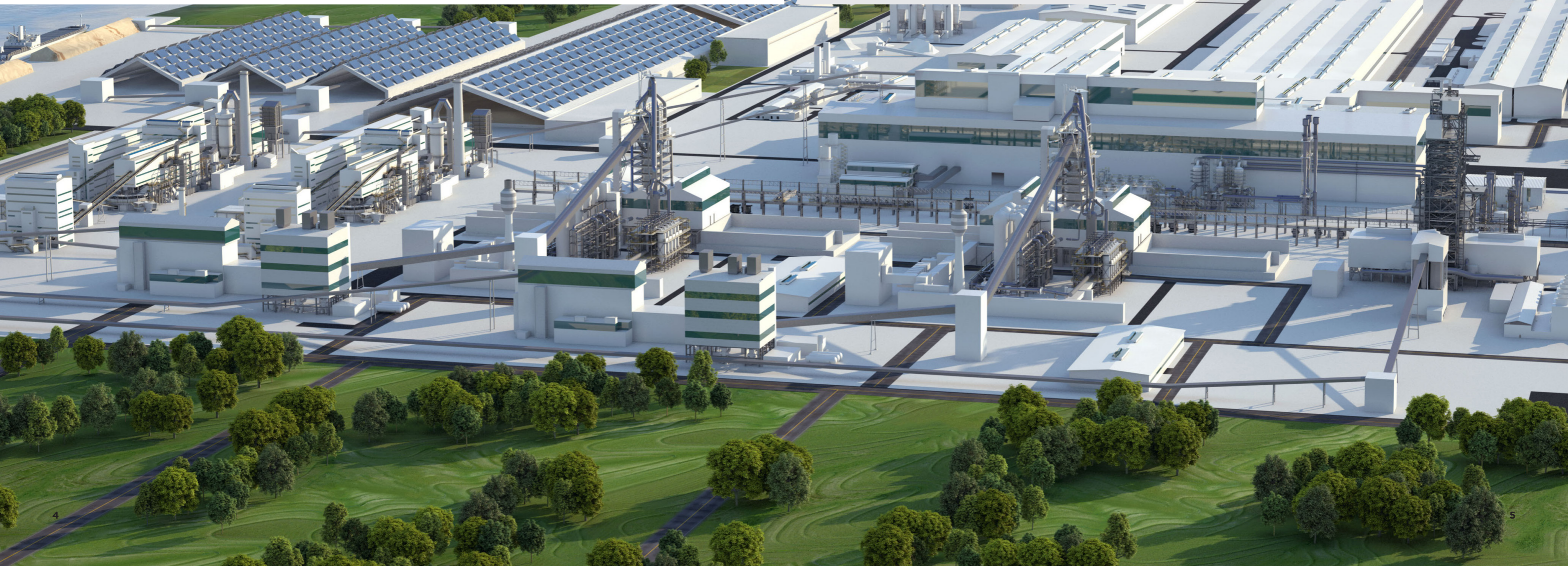

DDS - DRY DEDUSTING SYSTEM FOR LD (BOF)

FOR HIGHLY EFFICIENT GAS CLEANING,
HIGH ENERGY EFFICIENCY AND MAXIMUM
AVAILABILITY



Evaporation cooler

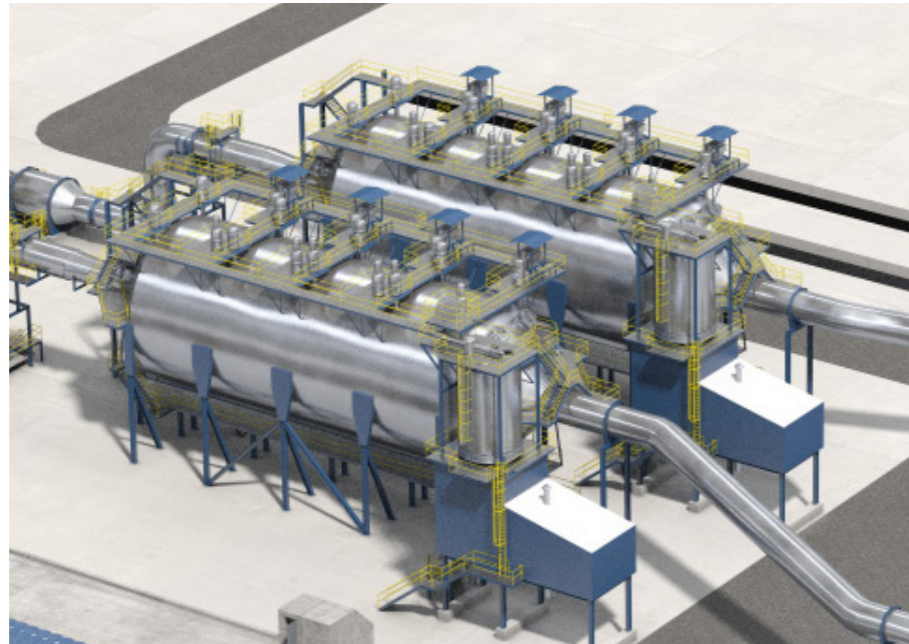

Cylindrically stopped electrostatic precipitator

Primetals Technologies' solutions for converter offgas cleaning and energy recovery focus on highly efficient gas cleaning, high energy efficiency and maximum availability.

For around ten years now, the dry dedusting process has become the state-of-the-art technology for maximum gas cleaning efficiency and minimum energy consumption for primary offgas in LD (BOF) converters.

The offgas is cooled in an evaporation cooler through the injection of a water-steam mixture. Fine cleaning of the waste gas takes place in the cylindrically shaped electrostatic precipitator (ESP), which features design solutions such as special electrodes, a dust extraction system, pressure relief devices, etc.

As a result of the very low pressure drop inside the dedusting plant, lower-power axial-type ID fans can be used (approx. 40% less than in conventional systems). With its round casing design, the ID fan is also fully pressure-peak resistant.

ECO SOLUTIONS - SAVING RESOURCES, CREATING VALUE

Saving resources

- Lowest dust emission levels of <math><10 \text{ mg/Nm}^3</math>
- Reduction of energy consumption by <math><45\%</math> (compared to wet type)
- No water treatment plant and sludge handling required
 - Overall capex lower than a wet dedusting system with a water treatment plant
 - Overall opex such as maintenance works and chemical dosing system not required

Creating value

- Lowest electric energy consumption of <math><5 \text{ kWh/t}</math> leads to reduction of conversion costs
- Increased gas recovery up to $100 \text{ Nm}^3/\text{t}$
- BAT conformity and thus a future-proof system compared to wet dedusting system
- Plant availability of >99%



WET VS. DRY DEDUSTING SYSTEMS FOR LD (BOF) CONVERTERS - GREEN FIELD INSTALLATIONS

	WET SYSTEM	DRY SYSTEM
Clean gas dust content (typical)	30 mg/Nm ³	10 mg/Nm ³
Energy consumption	100%	55%
Scrubbing water treatment plant (WTP)	yes	no
Investment costs	75%	100%
Total investment incl. WTP	100%	100%
Maintenance sensitive parts	scrubber, ID fan, pumps, sludge handling	dust conveyors ESP
Reliability of operation	high	high

Primetals Technologies has the competence to combine the lowest operating costs with the lowest emission levels. Emission levels of <math><10 \text{ mg/Nm}^3</math> can be achieved at operating costs of approximately €0.30/t.

The design of the dry dedusting system is based on tailor-made and advanced engineering methods such as numerical simulations as well as analytic and dynamic process models.

CFD simulations for gas flow and temperature distribution are essential to correctly define the shape and size of the evaporation cooler in order to ensure complete and homogeneous vaporization of the water and to avoid dust build-up at the inner evaporation cooler.

The ESP design has been optimized through the years for the best dust removal efficiency and the easiest plant maintenance possible.

All plant components, including the low-pressure axial-type ID fan, are designed for extra-long service life and maximum availability.

The energy input for the ESP can be reduced while maintaining the required clean gas dust concentration with a new additional design package:

- Dynamic high-voltage control according to actual process conditions
- Optimized electrostatic precipitator power input through dynamic online dust monitoring system (More information about Precon system on page 24)
- Separate power/voltage/current control for each single field (saving typically >30%)



WDS - WET DEDUSTING SYSTEM FOR LD (BOF)

A HIGHLY EFFICIENT DUST RECYCLING PROCESS

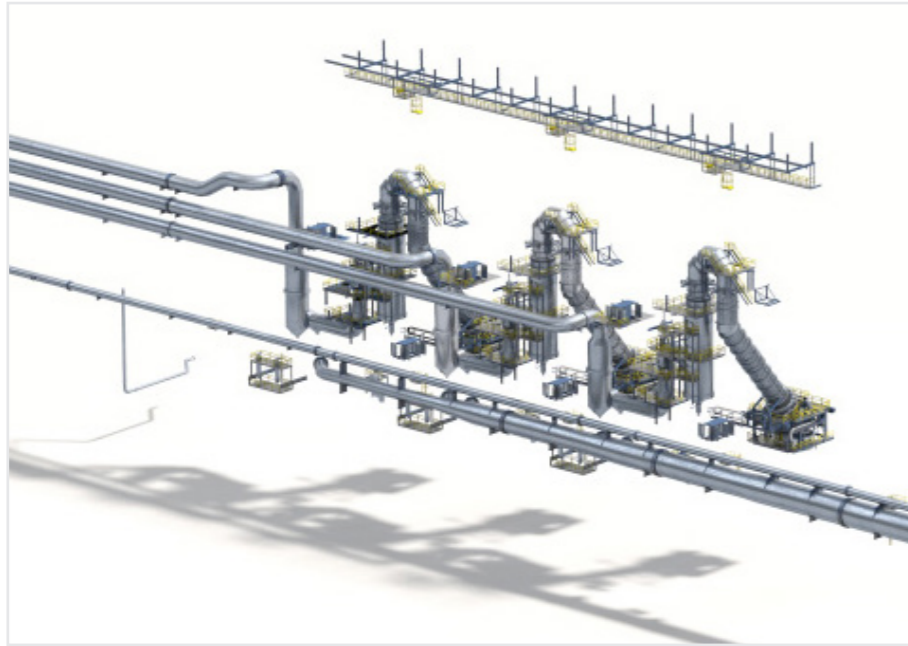

CONE wet-type dedusting system with split tower solution



CONE scrubber unit

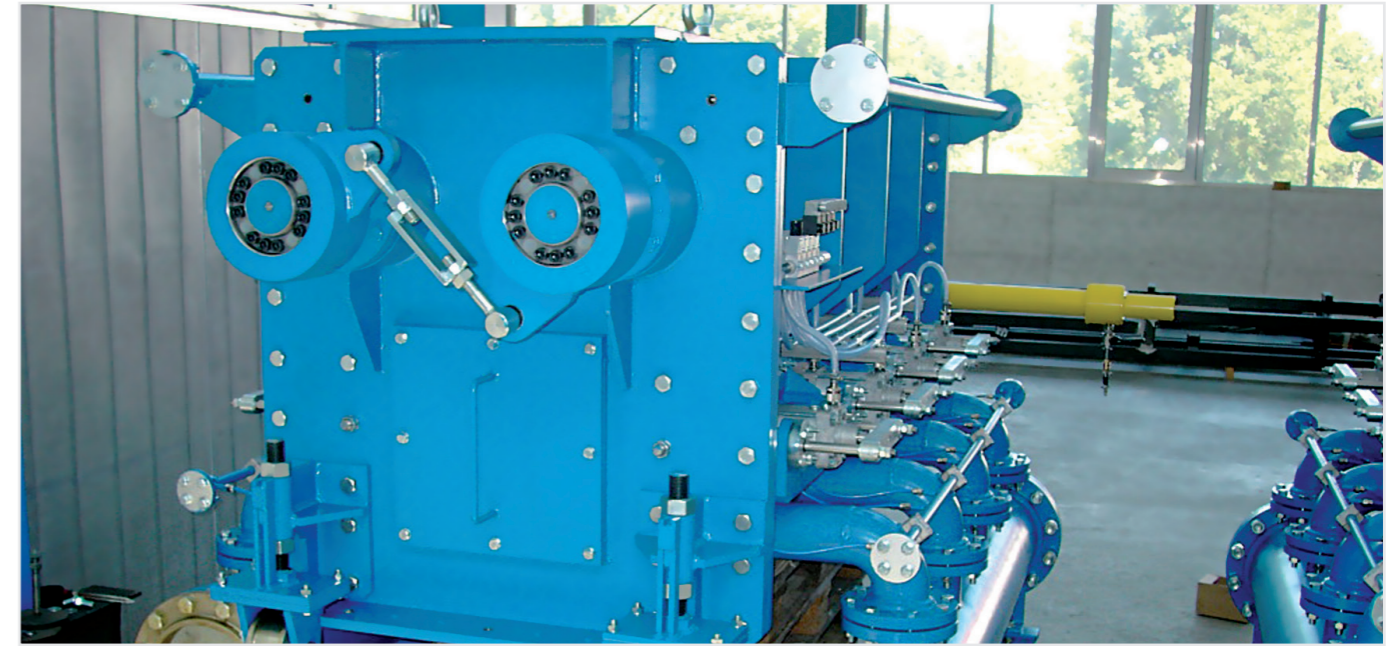

BAUMCO® wet dedusting system

Wet-type waste gas cleaning systems are installed in the majority of dedusting systems for LD (BOF) steel plants around the world. Wet dedusting systems are considered simpler in terms of operation and control.

Primetals Technologies offers two wet dedusting technologies:

- BAUMCO® scrubber system with venturi technology
- CONE scrubber system with annular gap technology

Both types are optimized to ensure maximum dedusting efficiency and the lower energy requirements.

CONE SCRUBBER SYSTEM WITH ANNULAR GAP TECHNOLOGY

Gases are accelerated in the annular gap between the inner and outer cone. Water is injected onto the inner cone to ensure uniform distribution. An intense mixture of gas and water takes place over the length of the annular gap and ensures optimum gas cleaning. Water and gas pass a demister to remove water droplets.

BAUMCO® SCRUBBER SYSTEM

Gases are accelerated in the convergent section at the venturi throat inlet and hit a transversely injected water spray. The laminar water spray injected from the sides forms a multiple self-regenerating filter so that even the finest particles are collected. Highly effective droplet separation downstream of the venturi scrubber ensures increased scrubbing efficiency and less wear of materials.

Additionally a patented 45° spraying technology is available to further improve the cleaning performance.



45° SPRAYING TECHNOLOGY

ECO SOLUTIONS - SAVING RESOURCES, CREATING VALUE

Saving resources

- Total emission reduction to <math><30 \text{ mg/Nm}^3</math>
- Reduced energy consumption of 10–20 kWh/t

Creating value

- 25% lower investment costs (compared to dry dedusting system)
- Plant availability of >99%
- Highly reliable and robust design, special solutions for reduced maintenance requirements

MAIN BENEFITS

- High performance scrubbing
- High system reliability
- Low maintenance requirements
- Space saving design as single or split tower solution
- Simplified plant control- and automation system
- All serviceable units externally mounted
- 45° spraying technology to boost cleaning performance

33
SUCESSFULLY
INSTALLED
DEDUSTING
SYSTEMS

SDS - SECONDARY DEDUSTING SYSTEM FOR STEELMAKING PLANTS

EFFICIENT CAPTURE OF DUST EMISSIONS AT THE POINT OF ORIGIN

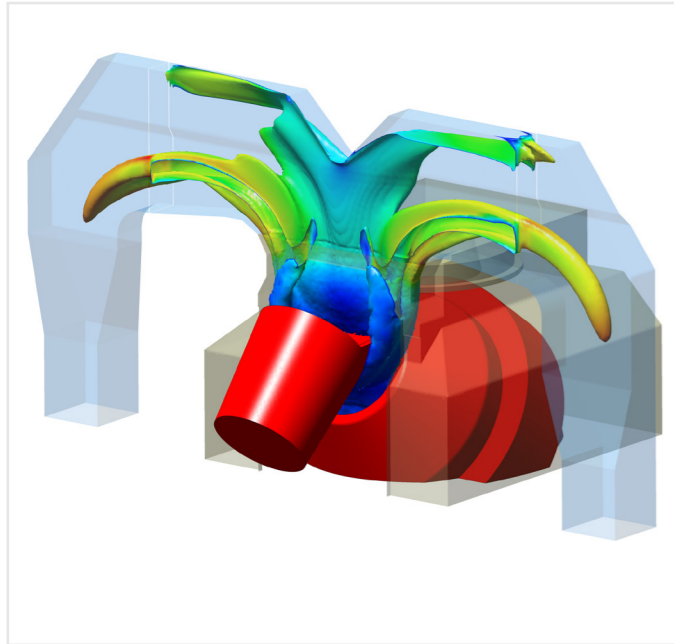

Optimized hood design for maximum achievable suction flow



Fan house and stack

The main task of a secondary dedusting system is to efficiently capture dust emissions that occur during the handling and processing of hot metal and liquid steel (e.g., charging, tapping, reladling, desulfurization, deslagging). The proper design and location of hoods is essential to achieve the highest dust efficiency and ensure clean ambient conditions inside and outside the steel shop.

A major process improvement is the patented Primetals Technologies peak cooler technology. Peak coolers absorb temperature peaks during hot metal charging and reduce the need for additional cooling air. Hence, this innovative technology based on thermal energy storage leads to reduced dilution air demands and reduced offgas volume flows.

This solution reduces investment and operating costs. Operational safety is increased and higher productivity is achieved through a higher charging speed.

The spark eliminator prevents sparks and slag particles from damaging the filter bags. Particles with a higher density are separated through an increased centrifugal acceleration.

The advanced pulse-jet filter from Primetals Technologies removes dust from the raw gas stream and assures highly efficient dedusting and increased lifetime of filter bags.

PRIMETALS TECHNOLOGIES OFFERS A WIDE RANGE OF CAPACITIES FOR SECONDARY AND AUXILIARY DEDUSTING PLANTS

- High flow capacity: 600,000–2,600,000 m³/h
- Medium suction rates: 200,000–600,000 m³/h
- Low suction rates: <200,000 m³/h

MAIN BENEFITS

- Thermal power control via traffic light guide; red indicates to the crane operator not to interrupt hot metal charging
- Thermal power control via crane interlock so that with fast-moving scrap the charging sequence is interrupted and restored to an optimized charging speed
- Emergency air damper controlled via a temperature controller protects the filter from thermal overload and provides ambient air to dilute and cool the hot offgas
- Static cooler means less risk to operate with under-stoichiometric combustion conditions
- Personnel is protected from high dust loads
- Optimized design for suction hoods and required suction rates through CFD modeling
- Primetals Technologies has developed and applied this solution especially for retrofit- and revamping projects were high-performance secondary dedusting systems have been successfully installed in many old steel making shops



Secondary dedusting system for highly efficient emission control

ECO SOLUTIONS – SAVING RESOURCES, CREATING VALUE

Saving resources

- Total emission reduction of <3 mg/Nm³
- Cost savings of €480,000 per ton and year when using the static cooler
- Energy consumption reduced by 25–45 kWh/t
- Design gas flow reduced up to 50%

Creating value

- Recycling of by-products via oxide briquetting possible
- Plant availability of >99%
- Clean working environment results in reduced maintenance costs



#1
SUPPLIER WORLDWIDE
- with the most advanced technology
- for new installations and
- revamping projects alike

PEAK COOLER EFFICIENT GAS COOLING DURING HOT METAL CHARGING



Peak cooler

The peak cooler from Primetals Technologies is a major advancement in secondary dedusting. Peak coolers absorb thermal heat that is released during charging and allow shorter charging periods and increased safety.

MAIN BENEFITS:

- Equalizing of temperature peaks
- Less cooling air required

54
SUCCESSFULLY
INSTALLED
DEDUSTING
PLANTS

GAS RECOVERY FOR LD (BOF) CONVERTERS

AN ECONOMIC, ECOLOGIC AND COMPLETELY INTEGRATED SOLUTION



Gas holder



Integrated gas recovery solutions

LD (BOF) gas recovery is an economic and ecologic solution for LD (BOF) primary waste gas treatment that is completely integrated. The main equipment for the LD (BOF) gas recovery is the gasholder plus the pressure boosters and distribution network. The technologically most complex part of the gas recovery system is the so-called switch-over station, where the gas is switched from flare stack to gasholder.

Depending on the primary dedusting plant configuration, Primetals Technologies can offer switch-over stations for the wet-type and dry-type dedusting process with their individual specific requirements. In the wet-type dedusting plants, the switch-over station features a three-way valve as the main control valve plus a series of parallel safety valves downstream. For dry-type dedusting plants, the switch-over station is designed with special, high-temperature-resistant cup valves.

The main focus of the plant solutions for LD (BOF) gas recovery is on high-calorific-value CO-gas-enrichment efficiency, plant reliability and safety.



Switch-over station for dry-type dedusting



Switch-over station for wet-type dedusting

ECO SOLUTIONS – SAVING RESOURCES, CREATING VALUE

Saving resources

- Reduced energy consumption to <math><1\text{ kWh/t}</math>
- Substitution of natural gas

Creating value

- Recovered energy up to $100\text{ Nm}^3/\text{t}$ of steel converter gas
- Additional earnings up to $\text{€}5/\text{t}$

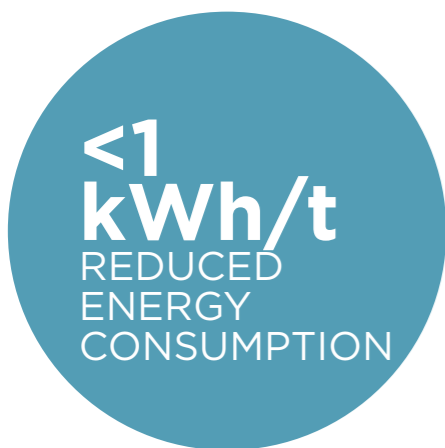

COOLING STACK

HIGHLY EFFICIENT ENERGY RECOVERY FOR LD (BOF)



Partially assembled cooling stack in the workshop

Converter waste gas cooling is highly challenging due to the tough operating conditions with high loads of abrasive dust particles as well as high temperatures and the general cyclic nature of this batch process.

Primetals Technologies ensures high plant availability and best performance by applying state-of-the-art and proven designs and materials along with most modern calculation tools for dynamic simulation of process conditions such as heat flow, steam circuit, etc.

In most cases, today the LD (BOF) converter cooling stacks are used for steam generation. Major benefits of the evaporative-cooled cooling stack system include value creation from waste, energy savings and reduced CO₂ emissions.

The system is typically designed for suppressed combustion in combination with CO gas recovery at a post-combustion factor between 0.1 and 0.2. The adjustable skirt is lowered during oxygen blowing to close the gap between the converter mouth and cooling system to minimize indraft of false air. The suction pressure in the converter hood area is controlled by downstream facilities based on closed-loop pressure control.

Heat is transferred from the waste gas through the heating surface to the cooling water, thereby generating steam.

The steam is stored in a steam accumulator for constant feed into the overall plant steam network. To minimize operational costs, the cooling stack system can be operated in assisted or natural circulation mode.

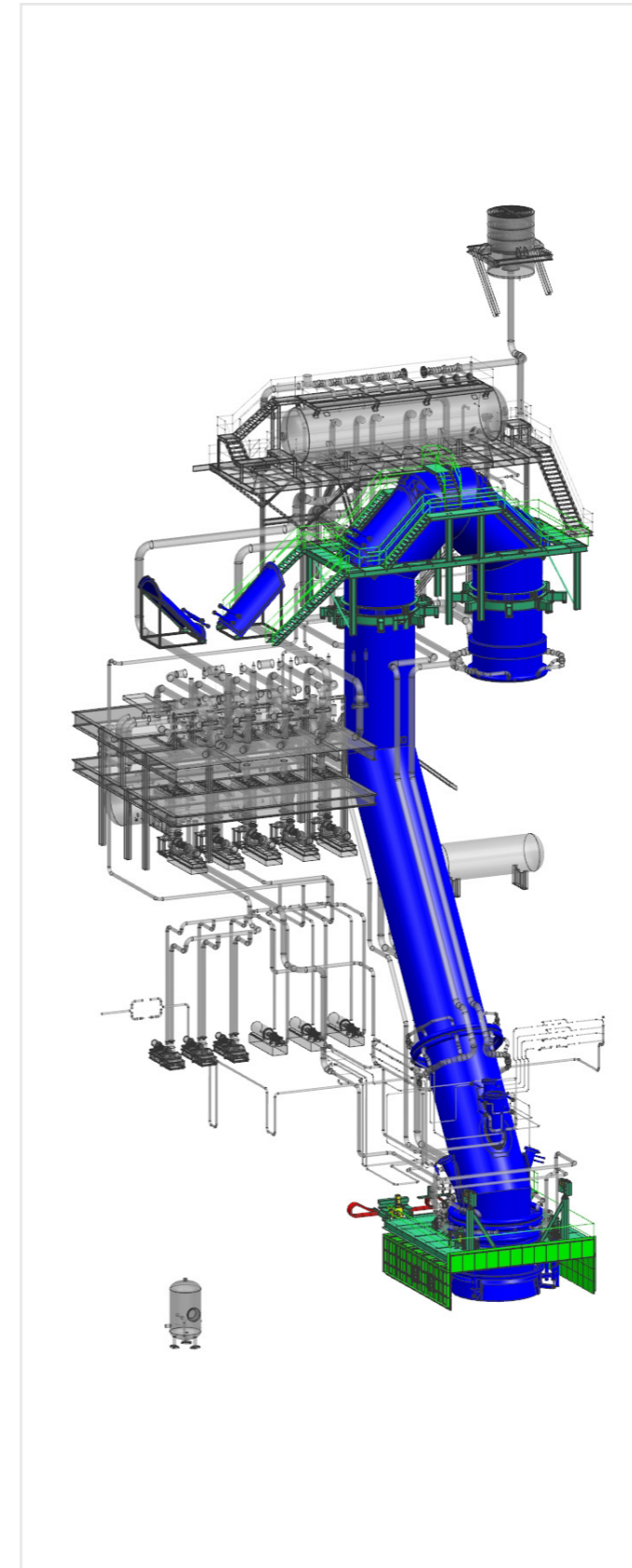

Cooling stack 3-D model



Cooling stack

ECO SOLUTIONS - SAVING RESOURCES, CREATING VALUE

Saving resources

- Energy consumption minimized by <1 kWh/t (natural circulation)

Creating value

- Maximum energy recovery of 80 kg steam per ton of liquid steel or 60 kWh/t of liquid steel
- With the value of steam assumed at €20/t, the cost of steam turns into savings of €0.16 per ton of liquid steel
- Steam production can lead to additional earnings of up to €2/t

28
SUCCESSFULLY
INSTALLED
ENERGY RECOVERY
PLANTS

DEDUSTING SYSTEM FOR ELECTRIC ARC FURNANCE

MEETING ENVIRONMENTAL STANDARDS IN ELECTRIC STEELMAKING



Primetals Technologies dedusting plant



Bag filter plant with stack



EAF dry dedusting system bag filter plant and stack

As a state-of-the-art system integrator for EAF dedusting equipment, Primetals Technologies offers comprehensive in-house solutions for primary and secondary offgas treatment. These proven solutions are characterized by effective cleaning and cooling of the offgas, and compliance with stringent environmental emission regulations.

Primetals Technologies provides profound knowledge about the whole process of electric steelmaking and respective environmental technologies. Its know-how comprises:

- EAF process calculation combining process knowledge with environmental know-how
- Dynamic thermodynamic simulations
- Fluid dynamics simulation to optimize environmental efficiency
- Analytical calculation tools for dedusting equipment developed by our specialists

In order to address specific requirements regarding reduction of dioxins or heavy metals in the EAF offgas, Primetals Technologies has developed a package solution based on activated carbon injection upstream of the bag filter.

ECO SOLUTIONS - SAVING RESOURCES, CREATING VALUE

Saving resources

- Total emission reduction of $<5 \text{ mg/Nm}^3$
- Reduced energy consumption by $<35 \text{ kWh/t}$
- Clean working environment results in reduced maintenance costs
- Complete recycling of by-products via oxide briquetting

Creating value

- Combination with energy recovery system for up to 45 kWh/t
- Plant availability of $>99\%$

AOD DEDUSTING

AOD dedusting systems are based on the same highly efficient dedusting technology as EAF dedusting systems. Both systems apply complete combustion of the furnace offgas for zero carbon monoxide emissions.

ECO SOLUTIONS - SAVING RESOURCES, CREATING VALUE

Saving resources

- Total emission reduction of $<5 \text{ mg/Nm}^3$
- Reduced electric power consumption of $<35 \text{ kWh/t}$
- Clean working environment results in reduced maintenance costs

Creating value

- Upgrade with the modular waste heat recovery system utilizes the thermal power of the offgas

113
SUCCESSFULLY
INSTALLED
DEDUSTING
PLANTS

ENERGY RECOVERY FOR ELECTRIC ARC FURNANCES

HIGHLY EFFICIENT WASTE HEAT RECOVERY SYSTEM

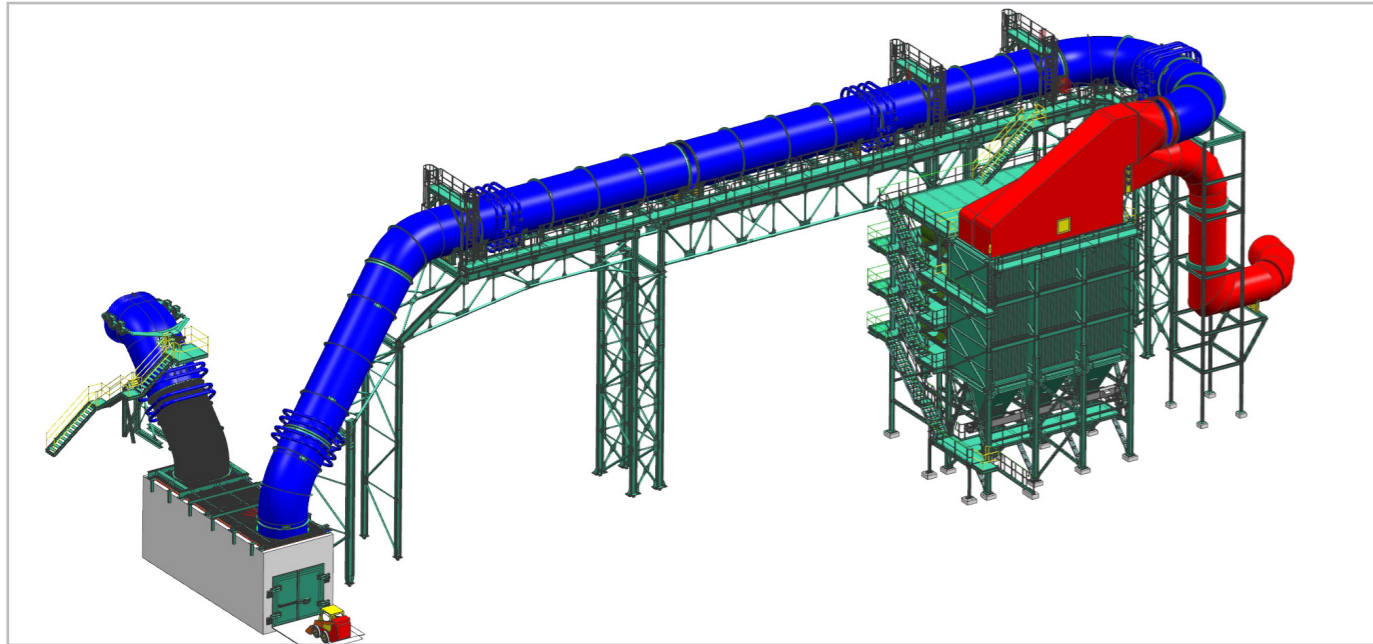

3-D plant layout of heat recovery system

Most electric arc furnace offgas systems are not thermally optimized, so only nearly 30% of the energy input in the electric arc furnace is used further.

Primetals Technologies provides electric arc furnace operators with highly efficient energy recovery systems. The integral energy recovery approach is based on a modular dedusting system set-up. Basically, either the hot gas line or the forced-draft cooler or both aggregates can be exchanged by an adequate energy recovery system.

The modular energy recovery solutions have the same layout as the standard dedusting solutions and can therefore be easily exchanged.

The discontinuous steelmaking process leads to a variable thermal energy output. Thermal energy storage systems like steam accumulators or thermocline storage tanks provide downstream consumers with a constant amount of heat.

The electric arc furnace energy recovery system is based on two steps, depending on the demand of energy to be recovered.

In the first stage the water-cooled hot gas line is replaced by an energy recovery system.

In the second stage the secondary offgas cooling device (e.g., forced-draft cooler) is additionally replaced by an energy recovery system.

The recovered energy can either be used for hot water production (heating or cooling), steam generation for internal or external steam consumers (processing or secondary metallurgical devices) or for electricity generation.

For greenfield minimills, energy recovery solutions and waste heat utilization concepts are an integral part of the dedusting line.

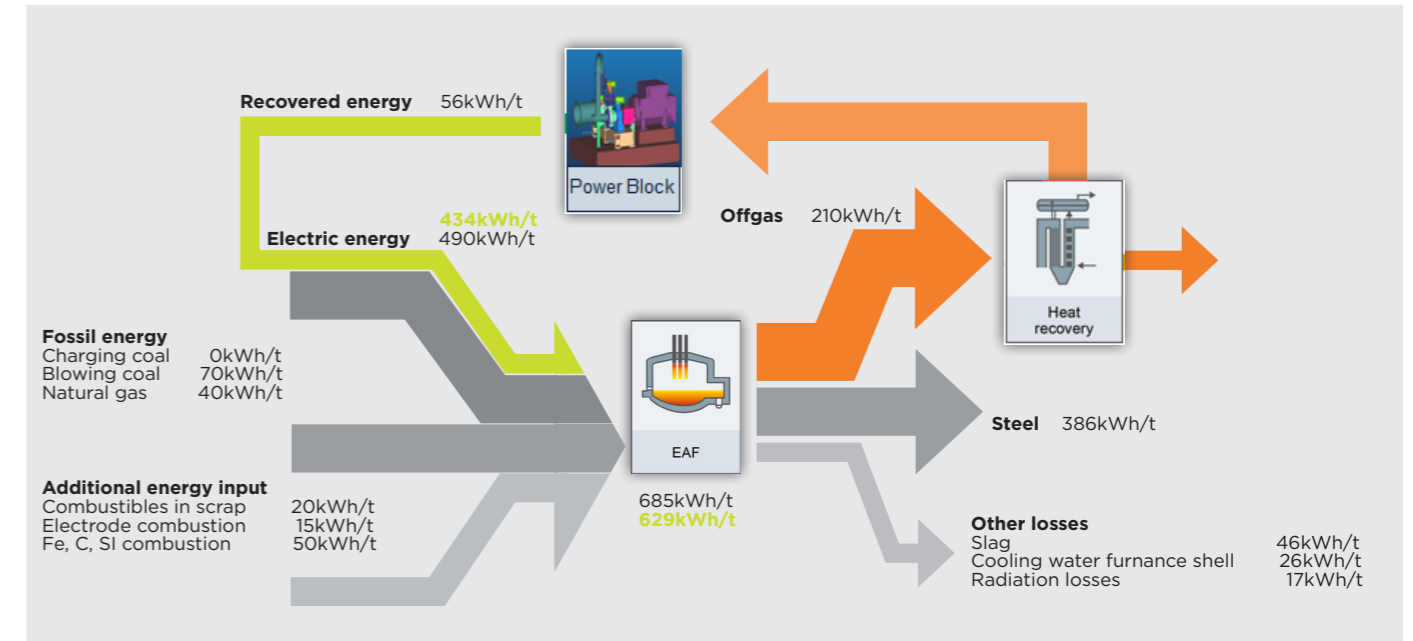

Reduced specific energy demand per ton of steel

ECO SOLUTIONS - SAVING RESOURCES, CREATING VALUE

Saving resources

- Emissions minimized by 5 mg/Nm³ using a modular system based on highly efficient EAF dry dedusting solutions

Creating value

- Energy recovery solution stage 1 and 2 up to 120 kg/t liquid steel or 100 kWh/t liquid steel
- With the value of steam assumed at €20/t, the cost of steam turns into savings of €0.20/t of liquid steel
- Up to 100 Nm³ per ton of steel converter gas for additional earnings up to €5/t



ENERGY RECOVERY FOR AOD

AOD energy recovery systems are based on the same highly efficient technology as EAF recovery systems.

A two stage solution helps customer to optimize waste heat recovery in accordance with waste heat utilization. Depending on the individual requirements the first cooling stage for the AOD waste heat recovery system can be realized either as hot water or steam cooled equipment. Additionally the second stage cooling equipment (e.g. forced draught cooler) is replaced by an waste heat boiler or an heat exchanger.

ECO SOLUTIONS - SAVING RESOURCES, CREATING VALUE

Saving resources

- Emissions minimized by 5 mg/Nm³ using a modular system based on highly efficient EAF dry dedusting solutions

Creating value

- Energy recovery solution stage 1 and 2 up to 110 kg/t liquid steel or 90 kWh/t liquid steel
- With the value of steam assumed at €20/t, the cost of steam turns into savings of €2.2/t of liquid steel

BSSF TECHNOLOGY FOR SLAG PROCESSING

LOW EMISSION IN CLOSED SLAG GRANULATION PROCESS, SHORT PROCESSING TIME, UNIFORM GRAIN SIZE AND LOW FREE LIME CONTENT



BSSF plant at Baosteel

Slag from steel production in LD (BOF) converters and electric arc furnaces can, for example, be used as material in road or railway track bed construction. In the Baosteel Slag Short Flow (BSSF) granulation process developed by Baosteel, the liquid slag is transferred to a granulation drum where it is treated with injected water with a dwell time between three and five minutes, which significantly reduces the amount of unreacted free lime. The hermetically sealed vessel and central vapor extraction system ensure that all emissions of dust and hazardous substances are avoided.

The process is already in use at Baosteel and several other Chinese steel producers, the Korean Posco group and the Indian company JSW Steel. The batch-wise operating BSSF plants have short process times and a compact design.

They achieve a high level of slag and crude steel metal separation, uniform granulation and a consistently high quality in the end products.

Primetals Technologies and Baosteel Engineering & Technology Group Co. Ltd., a subsidiary of the Baosteel Group, are cooperating in the granulation of slag produced in LD (BOF) converters and electric arc furnaces.

Primetals Technologies already offers solutions for slag granulation from pig iron production in blast furnaces.



Granulated slag

RECYCLING OF BY-PRODUCTS

FERROUS BRIQUETTING



Briquetting plant

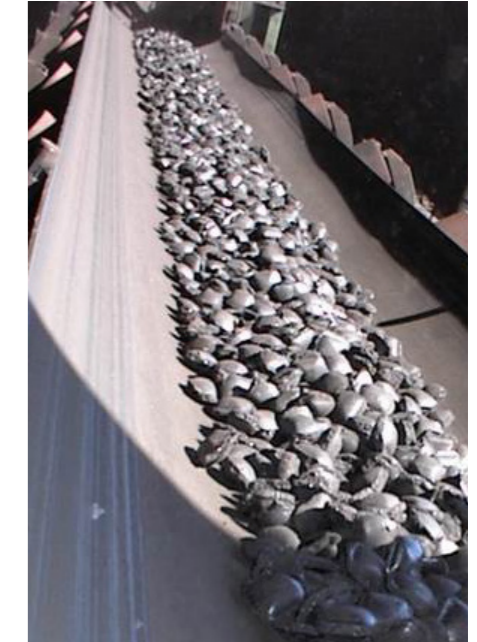

Briquette product

Around the world, government regulations concerning environmental care are becoming more stringent, also in regard to regulations and restrictions for depositing and storing dust and sludge generated in the iron- and steelmaking process.

These by-products such as iron-containing dust, sludge, oxide fines and scales as well as, for example, lime dusts become a valuable resource and recycling becomes a profitable activity within a plant. Up to 10% in mass of the total steel output of by-product materials are generated within an integrated steel plant with an iron content ranging from 50% to 65%. In DRI-based plants, a large amount of oxide fines, DRI sludge and DRI fines are generated, either as a result of the process itself or during material and product handling.

In many cases, these by-products may be used as feed material input in sinter plants without further processing, or sold at low value in order to avoid the space-consuming and sometimes costly option of depositing the materials in- or outside the plant.

However, in many DRI-based plants there is no sinter plant available for recycling, and the most effective way to make use of the materials is in the direct reduction plant as a partial pellet or lump-ore substitute. Not surprisingly, the reuse of these by-products in direct reduction plants is currently not state-of-the-art. Therefore, Primetals Technologies has performed comprehensive studies and tests on briquetting iron-containing by-products. To verify the physical stability and chemical reducibility of the briquetted material, extensive laboratory tests (e.g., static reduction tests) as well as field tests – so-called basket tests – have been performed and proved to be successful.

ECO SOLUTIONS – SAVING RESOURCES, CREATING VALUE

Saving resources

- Reduction of raw material consumption and thus operating costs due to recycling of by-products (lump ore, pellets)
- Sinter, pellets or lump ore bring savings of up to 7%

Creating value

- Minimization of landfill and transport costs
- Short payback period

GASFERM

GENERATION OF ADDED VALUE FOR STEEL MILL OFFGASES

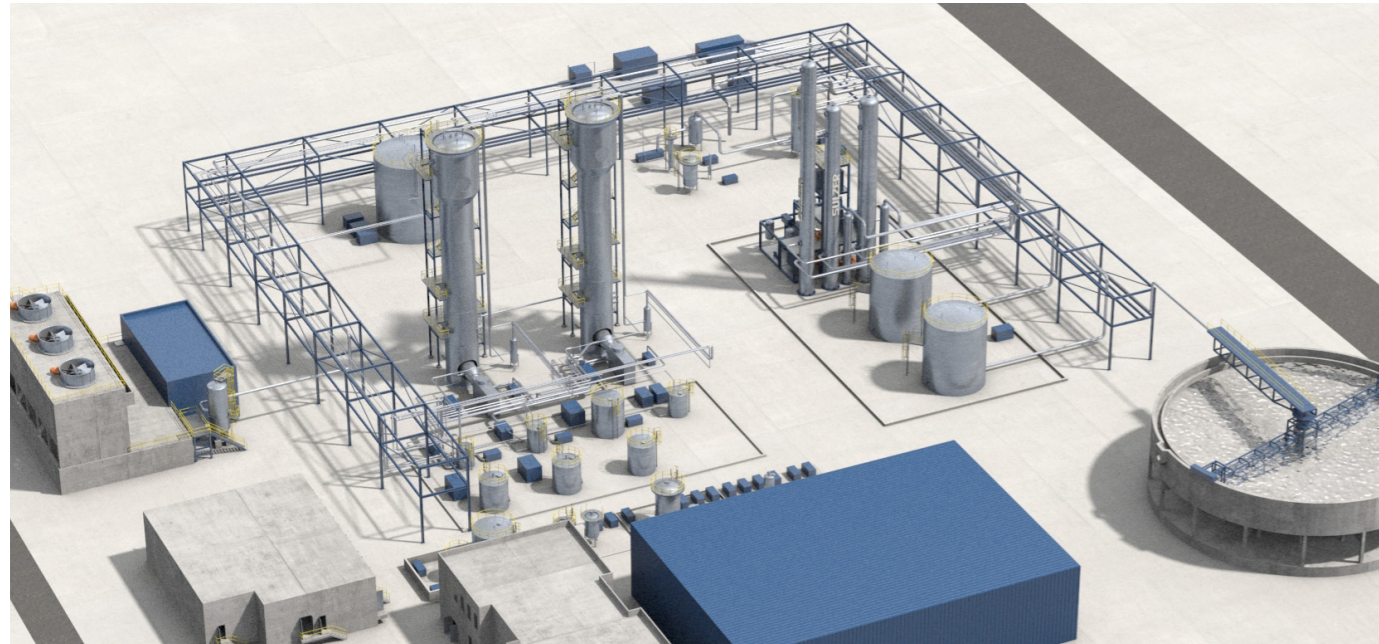

3-D plant layout for a double train installation

Recycling carbon emissions from steel mills provides an important new source for fuel and chemical production while simultaneously reducing a steel mill's carbon footprint. Offgases generated from iron and steel production contain significant amounts of carbon monoxide (CO), carbon dioxide (CO₂) and sometimes also hydrogen (H₂). Governments around the world are setting ambitious targets for reduction of stationary carbon emissions from industrial installations such as the steel industry, thereby adding significant costs to steel production.

GasFerm is a new development in offgas recycling that simultaneously addresses the need to reduce the steel industry's carbon footprint while improving a steelmaker's economic competitiveness through promotion of the circular economy.

Microbial fermentation of carbon and hydrogen-rich offgases, such as coke oven gas, blast furnace top gas, direct reduction gas and converter gas to produce ethanol or other basic chemicals, substantially mitigates CO₂ emissions while simultaneously reducing NO_x, SO_x and particulate emissions. The fuels and chemical products produced in this manner deliver superior economic returns. Greenhouse gas emissions from ethanol are up to 80% lower compared with conventional gasoline, and between 30% and 50% lower per MJ of energy recovered when compared with combustion for electricity generation.

This technology is developed by LanzaTech. Primetals Technologies is partner for plant implementation for the iron and steel industry.

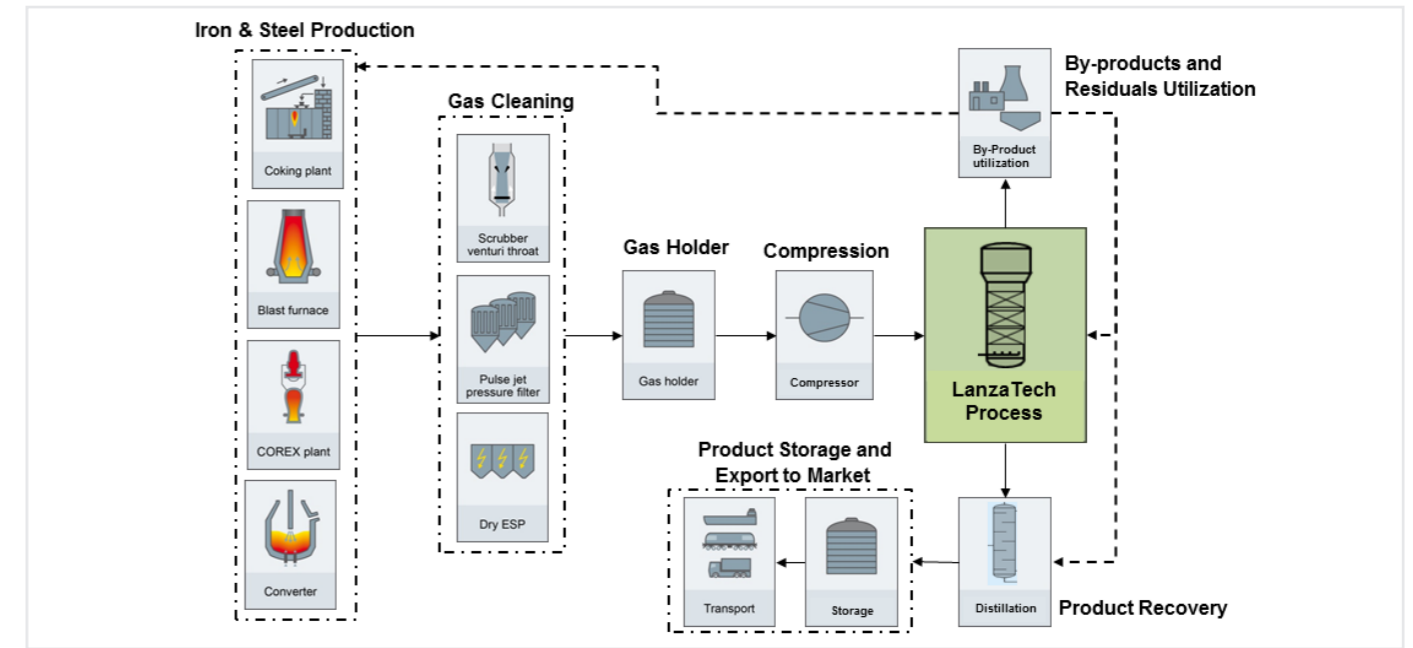
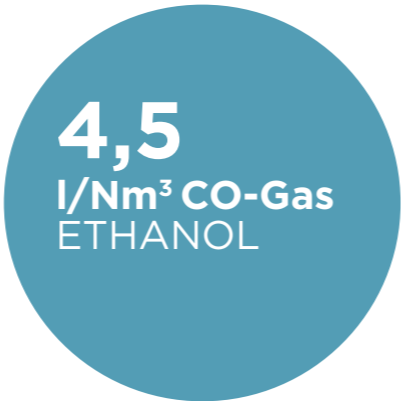

100% process gas recovery and utilization

MAIN BENEFITS

- Added value for carbon-rich co-generation gases
- Fuels and chemicals can be stored and globally traded, while electrical power cannot
- Chemical co-production adds diversification to the steel business
- GasFerm is a closed-loop, zero-waste process

ECO SOLUTIONS - SAVING RESOURCES, CREATING VALUE

Saving resources

- Minimum 30% reduction in carbon footprint vs. power generation
- Energy conversion efficiency is 60% compared with power generation efficiency of 35% to 40%
- No food-crop usage as in other ethanol processes

Creating value

- Net profit of ethanol produced is up to two times higher than electrical power generation
- 11 liters of ethanol per ton of liquid steel produced
- Project internal rate of return (IRR) in the range of 25% to 30%
- Production cost per liter of ethanol up to 25% lower than typical process for bio-ethanol production
- Produced biomass replaces coal in sinter or blast furnace (23 MJ/kg biomass)
- 100% process gas recovery and utilization



ELECTRICAL AND AUTOMATION SOLUTIONS



Converter control room at Taiyuan ISCO, China

LD (BOF) PROCESS OPTIMIZATION

With LD (BOF) Optimization and Dynacon, Primetals Technologies offers two well-proven automation solutions for high product quality at low production costs. Depending on the available measuring devices, one or the other system will be applied: Whereas Dynacon uses continuous offgas measurement data for dynamic control and automatic stop of oxygen blowing, conventional LD (BOF) Optimization improves temperature and carbon hitting rates based on substance measurement.

Both systems include advanced models in order to prepare, supervise, and dynamically optimize the converter process. Exact pre-calculation of required materials, comprehensive considering of all actual process parameters as well as dynamic control of oxygen blowing enable thermal and metallurgical control of converter steelmaking. Overheating of the steel bath can be eliminated and reblows are significantly reduced.

MAIN BENEFITS

- Increased productivity and yield
- Improved hitting rate for steel temperature and carbon content
- Reduced CO₂ emissions due to lower reblow rate and avoidance of overblowing
- Energy savings of up to 3%
- Lower consumption of raw materials and resources

PRECON

Based on the converter phase and actual process conditions, Precon controls the level of possible energy reduction without affecting overall dedusting performance. All relevant process data are analyzed during operation, and the power reduction calculation is sent to the individual high-voltage units of the ESP. Precon can be used for all primary dry-type dedusting systems with electrostatic precipitators in steel plants.

The electrostatic precipitator (ESP) is one of the main components in dry-type dedusting plants, at the same time it is also one of the main electrical consumer. Therefore Primetals Technologies supply efficient high-voltage units for ESP operation for best cleaning results. To reduce the energy consumption of new or existing ESPs Primetals Technologies provide a product for energy saving in combination with highest efficiency:

MAIN BENEFITS

- Energy savings up to 60%
- Short payback time
- Optimized dedusting control of the electrostatic precipitator
- No dust concentration increase in the clean gas
- Short implementation and commissioning time
- Easy to use system
- Fast implementation into existing systems

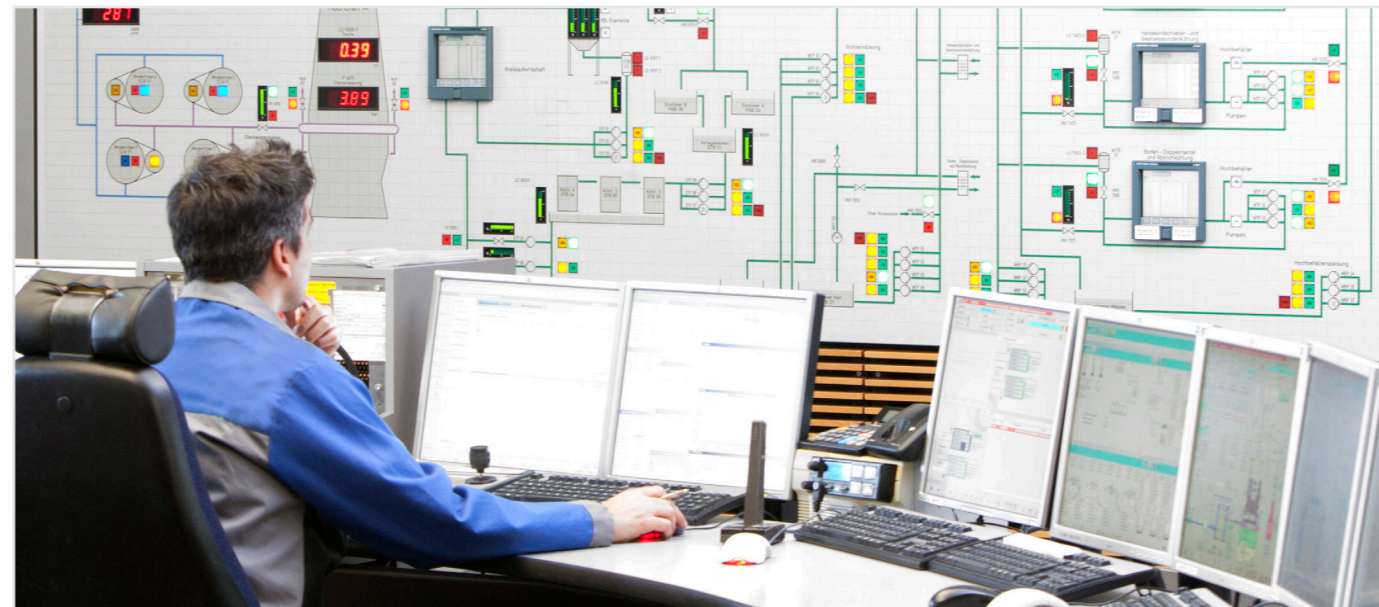

Blast furnace control room

HIGHEST PRODUCTION QUALITY AND COST-OPTIMIZED OPERATION – SINTER OPTIMIZATION

This system enables major cost savings and process improvements without compromising raw material selection, sinter quality, energy efficiency, and productivity. Optimized raw mix calculation allows the production of sinter material of the highest quality, while at the same time effectively reducing fuel consumption. Furthermore, the system provides a complete history of process parameters including recipe, chemical and physical raw material properties, and process measurements for a comprehensive analysis of the sinter process. The result is smooth sintering operation around the clock, an increased equipment lifetime and reduced production costs.

MAIN BENEFITS

- Monitoring of process measurements and indices becomes more efficient
- Process control practices become more uniform by using fully closed-loop operation on the basis of all provided expert system rules
- Higher productivity (increase by up to 5%)
- Stabilization of product quality (decrease of standard deviation by 5-10%)
- Reduced fuel consumption (decrease by up to 3%)

ENSURING SAFE AND COST-EFFICIENT OPERATION – BF OPTIMIZATION

The BF Optimization system was developed to operate the blast furnace in a standardized way at stable operating conditions. This closed-loop expert system corrects even small deviations by automatically executing the required counteractions. This leads to cost-efficient operation and energy-efficient production of hot metal (HM).

Stable process conditions are indicated by reduced standard deviation of quality parameters such as hot metal temperature or silicon content and result in reduced fuel consumption of the blast furnace. Core modules are product quality and energy efficiency rules, the procedures for shutdown and start-up, the 3D hearth monitoring package and the burden distribution model. At the same time, data management and analysis tools provide process engineers with a sound information basis for further process optimization.

MAIN BENEFITS

- Reduction of fuel consumption by 5 kg/t
- Increased productivity (up to 3%) HM
- Reduced standard deviation of HM temperature and Si content (by 10%)
- Stabilization of operation by avoiding critical situations

PROCESS & TECHNOLOGY CONSULTING

INCREASE PLANT PERFORMANCE AND REDUCE CONVERSION COSTS



Consulting through out the whole metallurgical production chain

PROCESS AND TECHNOLOGY CONSULTING

You can profit from our integrated process know-how and global presence. Process and technology consulting help increase plant performance and reduce conversion costs to support quick and proper selection of feasible improvement measures.

Primetals Technologies offers technology-consulting services that help operators to achieve and maintain high standards in production excellence.

On the basis of decades of experience in the engineering, installation, start-up and commissioning of steelmaking plants worldwide, our specialists are skilled in identifying potential for plant performance improvement in the course of a performance check. Detailed and individual concepts are proposed to optimize processes and adapt technological equipment to deal with different qualities of raw material. By implementing these measures, operators can ensure permanent production excellence and stay in line with environmental goals and remain cost effective.

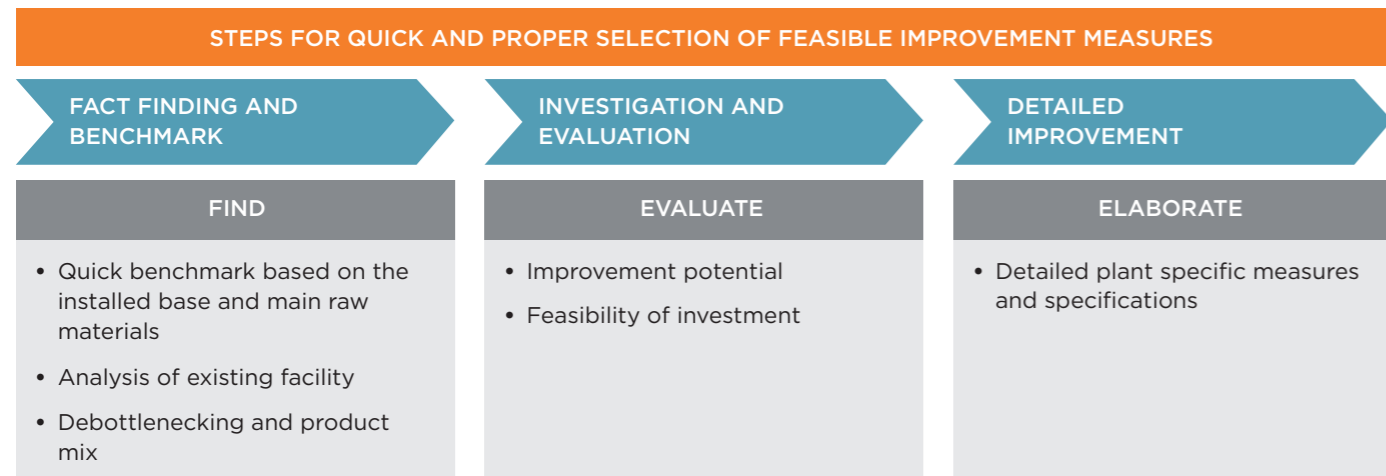

LIFE CYCLE SERVICES FOR YOUR PLANT



OPERATIONAL SUPPORT

BENEFIT FROM OVER 50 YEARS OF EXPERIENCE

Comprehensive services for metallurgical plants, from supply of original manufacturer components, spare and wear parts to consulting, technical assistance and training.



PLANT UPGRADES

LOW INVESTMENTS FOR STATE-OF-THE-ART TECHNOLOGY

Decades of experience worldwide in design, manufacturing, and commissioning as well as consulting of metallurgical plants ensure each client with innovative modernizations and mechatronic solutions for its processing chain.



MAINTENANCE SERVICES

ON-AND OFFLINE MAINTENANCE AND REPAIR SERVICES

With wide-ranging international network of customer support experts and worldwide repair and maintenance workshops, Primetals Technologies is your ideal single source partner for maintenance services.

With a portfolio consisting of operational support, plant upgrades, and maintenance services you can focus on your core business while Primetals Technologies assures your plant's optimum performance.

Fast, reliable, and experienced service and support for the metallurgical industry Primetals Technologies strives to be a long-term life-cycle partner dedicated to your success. We offer a full range of services across the entire life-cycle of your plant, including consulting and technical assistance, directly from a single provider. Our service portfolio ranges from a spare parts service available at just the right time to advanced staff training and technical support, upgrades of components and plants to be technical up to date; also from repair service of key components for a longer life-cycle, to online and offline maintenance. Our services reduce cost, increase productivity, improve product quality, and ensure safety.

SELECTED MODERNIZATION REFERENCES



REFERENCE HIGHLIGHTS

DRY DEDUSTING SYSTEM FOR LD (BOF)

Customer
THYSSENKRUPP CIA.
SIDERURGICA DO ATLANTICO
Type of plant
Dry dedusting system

OUR SOLUTION

Thyssen Krupp expanded to the Americas and set up a greenfield steel plant in Santa Lucia near Rio de Janeiro, Brazil. Primetals supplied state of the art dedusting systems for the entire steel shop. The LD (BOF) primary dedusting features a heat recovery system with steam generation, the first dry type dedusting system in all South and North America plus a gas recovery system. The plant was commissioned in 2010.

TECHNICAL DATA

No of converters:
2 pcs

Converter size:
330 tons

Converter offgas flow:
150.000 Nm³/h

Dust content of cleaned gas:
20 mg/Nm³

DRY DEDUSTING SYSTEM FOR LD (BOF)

Customer
Shougang Jintang United Steel
Type of plant
Dry dedusting system

OUR SOLUTION

In preparation for the Olympic games 2008 in Beijing Shougang was requested to relocate their steel production outside of the Beijing area. Shougang set up a 10 m.p./a. steel plant with five 300 t LD (BOF) converters in two phases. Primetals supplied dry dedusting systems to meet the strict environmental standards. A highlight was a special control system for management of simultaneous gas recovery on three converters into one single gasholder.

TECHNICAL DATA

No of converters:
5 pcs

Converter size:
300 tons

Converter offgas flow:
150.000 Nm³/h

Dust content of cleaned gas:
20 mg/Nm³

DRY DEDUSTING SYSTEM FOR LD (BOF)

Customer
U. S. Steel Kosice, s.r.o.
Type of plant
Dry dedusting system

OUR SOLUTION

US Steel made a big modernization of its steel shop No. 1 in Kosice (Slovakia). Of the three original converters one was removed. The other two lines were completely revamped including new suppressed combustion system cooling stack for heat recovery, dry dedusting systems and the required secondary dedusting systems. In 2013 a gas recovery system was added.

TECHNICAL DATA

No of converters:
2 pcs

Converter size:
180 tons

Converter offgas flow:
105.000 Nm³/h

Dust content of cleaned gas:
20 mg/Nm³

WET-DEDUSTING SYSTEM FOR LD (BOF)

Customer
SSAB Oxelösund, Sweden
Type of plant
Wet dedusting system

OUR SOLUTION

In order to meet the ever-increasing municipal emission limits in the primary offgas during converter steelmaking, SSAB (Oxelösund, Sweden) installed the latest wet-dedusting system (WDS) from Primetals Technologies. The original Baumco scrubber tower was converted to a Primetals CONE scrubber system, which represented the best solution in terms of investment costs, required installation time and dedusting performance. The plant was successfully put in operation in December 2015.

TECHNICAL DATA

No of converters:
1 pc

Converter size:
210 tons

Converter offgas flow:
100.000 Nm³/h

Dust content of cleaned gas:
30 mg/Nm³

SECONDARY DEDUSTING FOR LD (BOF)

Customer
OAO "Severstal"
Type of plant
Secondary dedusting system

OUR SOLUTION

In order to reduce the pollution situation and to reduce operational downtimes caused by heavy emissions in the steel shop in Cherepovets, Severstal decided to install a secondary dedusting system in the converter steel shop.

Primetals designed and supplied the retrofit system in the existing steel shop for the three 380 t LD (BOF) converters. The system was commissioned successfully in 2013.

TECHNICAL DATA

No of converters:
3 pcs

Total suction volume:
2.500.000

Filter type:
Bag filter

Total surface:
28.100

Converter tap weight:
380 tons

GAS RECOVERY SYSTEM FOR LD (BOF)

Customer
TATA Steel Port Talbot
Type of plant
LD (BOF) gas recovery system

OUR SOLUTION

Although equipped with a suppressed combustion primary dedusting system, the steel shop of TATA Steel Port Talbot (former CORUS), did not feature a gas recovery system until Primetals was awarded the contract to install the energy recovery system. Primetals and TATA Port Talbot jointly developed the project according to the highest safety standards in Europe and with smallest impact on ongoing plant operation.

TECHNICAL DATA

No of converters:
2 pcs

Converter size:
300 tons

Gasholder volume:
80.000 m³

Primetals Technologies Austria GmbH

A Group Company of Mitsubishi Heavy Industries

Turmstrasse 44
4031 Linz
Austria

[primetals.com](https://www.primetals.com)

Brochure No.: T02-2-N193-L4-P-V5-EN

Printed in Austria

© 2023 Primetals Technologies Ltd. All rights reserved

The information (including, e.g., figures and numbers) provided in this document contains merely general descriptions or characteristics of performance based on estimates and assumptions which have not been verified.

It is no representation, does not constitute and/or evidence a contract or an offer to enter into a contract to any extent and is not binding upon the parties. Any obligation to provide and/or demonstrate respective characteristics shall only exist if expressly agreed in the terms of the contract.

These estimates and assumptions have to be analyzed on a case-to-case basis and might change as a result of further product development.

Primetals Technologies excludes any liability whatsoever under or in connection with any provided information, estimates and assumptions. The provided information, estimates and assumptions shall be without prejudice to any possible future offer and/or contract.

Any use of information provided by Primetals Technologies to the recipient shall be subject to applicable confidentiality obligations and for the own convenience of and of the sole risk of the recipient.

Primetals is a trademark of Primetals Technologies Ltd.