

---

# **COLD ROLLING TECHNOLOGY**

## SOLUTIONS FOR COLD ROLLING MILLS

# OUR SOLUTION FOR YOUR CHALLENGE

## TRENDSETTING TECHNOLOGIES FOR COLD ROLLING MILLS

### QUALITY AND EXPERIENCE IN ROLLING TECHNOLOGY

The demand for cold rolled steel continues to grow, and at the same time the requirements for product quality, mill productivity, availability and reliability are increasing. The expertise and experience of Primetals Technologies have made our company one of the leading suppliers for the cold rolling industry, which is reflected in the fact that we have installed nearly 80 plants for carbon steel production within the last 10 years. In every one of our projects, we have proven to be the ideal partner.

### TECHNOLOGIES FROM A SINGLE SOURCE

You might be seeking a complete mill or a single section, modernization, extension, or the construction of a new plant. No matter what your needs are, we can support you with a complete spectrum of cold rolling technologies. The range of cold mills supplied by Primetals Technologies provides technology allowing strip to be produced at very tight tolerances and high productivity levels from carbon steel to special steel grades. Our cold mills comprise technology, mechanics, electrics, drives, and automation from a single source.

### INNOVATIVE TECHNOLOGIES

The name Primetals Technologies stands for permanent leadership in innovation. Primetals Technologies has unified the traditions of successful companies: Mitsubishi-Hitachi Metals Machinery, Clecim, Davy, VAI and Siemens VAI, all of which developed remarkable solutions in the field of cold rolling technology. Many of these achievements, which have now been combined, were introduced in collaboration with leading steel producers around the world. These complementary solutions and skills, as well as additional know-how resulting from our long-lasting cooperations with a number of institutes and universities, have led to further advances in cold rolling technology.

### LIFECYCLE PARTNERSHIP

As a lifecycle partner for steel producers, Primetals Technologies offers a complete range of products and services necessary for new investments and modernization.

### THE GLOBAL AUTHORITY IN METALS EXCELLENCE

As a globally active full-liner, we possess expertise that is unique within the entire steel production industry. Backed by our extensive experience, we devote much at our focus on process optimization for cold rolling mills. We cover everything from individual plant and logistics design to proven rolling technologies, including sophisticated automation packages.

### YOU CAN EXPECT

- Leading process technology
- High rolling speed and flexible production
- Complete and individual solutions that accommodate increasing quality requirements for cold rolled products
- Technologies that allow high-quality products
- Future-proof investments based on expandable solutions
- Low operating costs thanks to high plant availability



# COLD ROLLING SOLUTIONS FOR CARBON, AHSS, AND SILICON STEEL



Coupled PLTCM with in-line inspection station at AK Steel Dearborn, USA (former Severstal N.A.)



Reversing cold mill, ACCIL Auto Steel, Ltd., India



Additional no. 0 stand mill installation at no. 1 PLTCM at Kwangyang, POSCO, South Korea



Main pulpit of tandem cold rolling line, Ternium, Mexico

## TANDEM COLD ROLLING MILLS

Production capacities of tandem cold mills using coil-to-coil operation are typically in the range of 600,000 to 1,000,000 t/year. Today, many of the existing batch mills are extended and modernized to continuous mode operation, and new mills are installed for continuous operation right from the start. Depending on the product mix, production capacity of these continuous mills can then reach typically 125 % of batch operation, and many of the quality parameters are considerably improved.

## PICKLING LINE TANDEM COLD MILL

In recent years, most newly installed tandem cold mills have been continuous operation mills against traditional batch type mills. They are connected to pickling lines to raise productivity to 2,000,000 t/year and more.

Additionally, improvements in production yield, roll consumption, rolling flexibility, strip thickness, and flatness quality, as well as stable rolling and operation costs have been requested by our customers. Since 1971, Primetals Technologies has supplied more than 50 continuous mills coupled with pickling lines (PLTCM).

## SINGLE-STAND AND 2-STAND REVERSING COLD MILLS

Depending on the product mix, rolling capacities between 200,000 and 400,000 t/year are possible in a single-stand cold rolling mill. 2-stand reversing cold mills combine the flexibility of single-stand reversing mills with the capacities of conventional coil-to-coil tandem mills at substantially reduced investment costs. 2-stand reversing cold mills engineered by Primetals Technologies are suitable for highest quality applications and capacities from 400,000 to 800,000 t/year and higher.

## SINGLE- AND 2-STAND SKIN-PASS MILLS

Primetals Technologies supplies stand-alone and inline skin-pass mills of either single- or 2-stand design, to provide adjustment of the final mechanical properties, flatness, and surface finish of cold rolled strip.

## TEMPER AND DCR MILLS

After the reduction of the strip in the tandem cold mill and subsequent annealing, the double cold reduction mills (DCR mill) of Primetals Technologies further reduce the strip on the no. 1 stand and temper-roll it on the no. 2 stand, in order to reach the desired mechanical strength of the strip.

## MODERNIZATION AND TECHNOLOGY PACKAGES

New cold rolling mills have a lifetime of several decades. Modernization and upgrading of existing plants therefore is a decisive factor in keeping your mill state-of-the-art. Today, market demands for a wide range of steel grades, especially for high strength steel and advanced steel grades with superior strip quality, often require plant upgrades. Additional important factors in cold rolling are high yield, mill availability, and production throughput. Modernization of existing equipment often is the only effective way to continuously meet market requirements and to achieve the competitive level of conversion cost during the lifecycle of the mill. Primetals Technologies has vast experience in upgrading and modernizing cold rolling mills. Using a systematic approach, our company works closely with our customers to develop tailored modernization packages according to the specific requirements or constraints of the project.

Each solution may be purely mechanical, purely electrical, purely automated, or a combination of all of these. This includes everything from small packages such as surface inspection or improvement of the mill's lubrication system all the way up to an overall refurbishment and extension of your mill.

## AUTOMATION SOLUTIONS

Technological control and process models are at the core of any modern automation concept with the goal of maximizing utilization of the mechanical, electrical, hydraulic, and other control equipment. Control concepts have evolved with the increasing performance of the equipment and increasing demands in terms of tolerances of the final product – from simple analog PI controllers to highly complex and interlinked control systems. Today, these controls and process models are integrated, and the added value is well visible in the rolled strip.

## ADDED VALUES

- Improved gauge tolerances
- Less off-gauge material
- Perfect flatness to meet more stringent demands worldwide
- Maximum throughput

# COUPLED CONTINUOUS PICKLING AND TANDEM COLD MILLS

## ADVANCED TECHNOLOGIES AND KEY COMPONENTS FOR ROLLING HIGH-QUALITY STRIPS

For numerous product applications, the required strip thickness, flatness, and surface quality can be achieved more economically by coupling the pickling and cold-rolling processes. This results in significant improvements with respect to mill productivity, yield, and production cost savings due to the elimination of strip-threading and tailing-out operations. Maintenance, roll consumption, and manpower requirements are also reduced. Speed-optimization systems ensure the highest throughput rates under all operating conditions.

<b>High Gauge Accuracy</b>	High response hydraulic roll positioning system (HYROP), roller bearing for back-up roll, high response AC motor and pinion stand drive, up-to-date automatic gauge control (AGC) technique, mass flow AGC
<b>High Quality Steel (IF, HSS, DP, TRIP, etc.)</b>	High reduction by UCM, continuous operation mill, internal cleaning device, strip wiping system, fine coolant filtration, and iron separator
<b>Strip Flatness</b>	Automatic flatness control (AFC) with UCM function, UCM Flat control with multi-zone work roll cooling
<b>Energy Saving</b>	Effective scale breaker, high efficiency jet pickling, or iBox® pickling
<b>Energy Saving</b>	Energy saving due to small work roll diameter
<b>Productivity</b>	Automatic operation and continuous rolling, off-gauge reduction by continuous operation
<b>Stable Operation</b>	Trimming-width reduction through dual CPC, and high rigidity of UCM
<b>Reliability</b>	Reliable welder (laser type or flash-butt type)

### UNIVERSAL CROWN CONTROL MILL (UCM)

#### Main Equipment

- Positive/negative work roll bending
- Intermediate roll bending
- Intermediate roll shifting
- Best selection of mill type

#### Features

- High reduction capability
- Excellent shape, stable rolling
- Minimized strip crown

### CAROUSEL TENSION REEL

#### Main Equipment

- Flying shear (drum type)
- Carousel reel
- Belt wrapper
- Spool charger

#### Features

- High-speed threading
- Steady winding for thin gauge

### INSPECTION STATION

#### Main Equipment

- In-line or off-line inspection table
- Strip rotation unit

#### Features

- Easy and quick strip top and bottom surface inspection

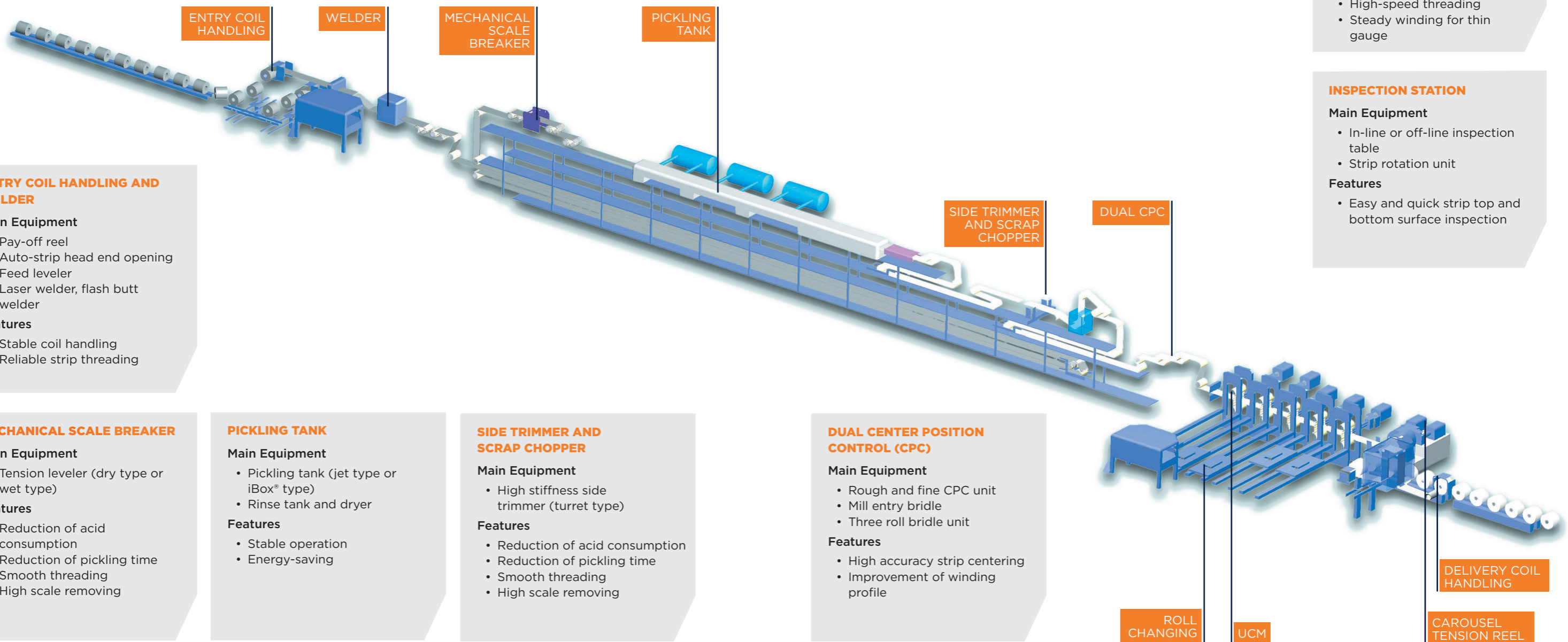

### ENTRY COIL HANDLING AND WELDER

#### Main Equipment

- Pay-off reel
- Auto-strip head end opening
- Feed leveler
- Laser welder, flash butt welder

#### Features

- Stable coil handling
- Reliable strip threading

### MECHANICAL SCALE BREAKER

#### Main Equipment

- Tension leveler (dry type or wet type)

#### Features

- Reduction of acid consumption
- Reduction of pickling time
- Smooth threading
- High scale removing

### PICKLING TANK

#### Main Equipment

- Pickling tank (jet type or iBox® type)
- Rinse tank and dryer

#### Features

- Stable operation
- Energy-saving

### SIDE TRIMMER AND SCRAP CHOPPER

#### Main Equipment

- High stiffness side trimmer (turret type)

#### Features

- Reduction of acid consumption
- Reduction of pickling time
- Smooth threading
- High scale removing

### DUAL CENTER POSITION CONTROL (CPC)

#### Main Equipment

- Rough and fine CPC unit
- Mill entry bridle
- Three roll bridle unit

#### Features

- High accuracy strip centering
- Improvement of winding profile

# TANDEM COLD MILLS

## COMPETENCE FOR YOUR SUCCESS



Tandem cold mill, voestalpine, Linz, Austria



Tandem cold mill, Hyundai Steel, Korea

### TANDEM COLD ROLLING MILLS

Tandem cold mills (TCM) for carbon steel as well as automotive applications require high reduction ratios for extremely deep drawn material. TCMs operate under high load conditions for high strength steels. 4- to 6- mill stand configurations are typically used for these requirements and combined with UCM technology featuring small work rolls and high response HYROP systems. Cold strip with excellent gauge and strip flatness accuracy can be produced.

An optimized mill guide system and the configuration of the coolant system ensure surface quality without roll marks and less residual oil and iron fines.

### 6-HIGH AND 4-HIGH TECHNOLOGY

Our process technology and automation experience for 6-high and 4-high technology make Primetals Technologies a unique partner for your new and retrofit cold mill projects.

### TECHNICAL FEATURES

- The 6-high UCM allows the rolling of all products with straight rolls, which again allows obtaining rapid start-up curves. This produces the most stable rolling and excellent flatness controllability from narrow to wide strip.
- In connection with axial roll shifting, the SmartCrown® contour can be applied for 4-high and 6-high mill stands.
- The patented in-line inspection station allows for quick and easy checks at the top end and bottom surface of the strip.
- Physical and analytical online models supported by neural networks ensure accurate mill setup to achieve tight tolerances right from the start.
- Flexible thread-in and thread-out strategies are applied for all materials.

- The use of the last stand in temper mode allows for smoothing or roughing strip surfaces.

### MILL CONFIGURATION

The required number of mill stands is determined by the target product mix. Our analysis of the customer's overall requirements will provide the best suitable technological solution. Our technology is used, for example, in the following automotive applications:

- AK Steel, Dearborn, USA (former Severstal N.A.) (5-stand TCM, UCM)
- Hyundai Steel, Korea (6-stand TCM, UCM)
- Panzihua Iron & Steel, China (5-stand TCM, UCM)
- Baosteel, Zhanjiang, China (5-stand TCM, UCM)
- voestalpine Stahl, Austria (5-stand TCM, 4-high SmartCrown®)
- TATA Steel, Netherlands (4-stand TCM, UCM)
- Tangshan Iron & Steel, China (5-stand TCM, 6-high SmartCrown®)
- Valin ArcelorMittal Automotive Steel Co. Ltd, Loudi, China (4-stand TCM, 6-high, linked to pickling line)

### OTHER APPLICATIONS

With non-grain oriented electrical (silicon) steel products, the thickness sharply decreases at the edges. To reduce, the edge drop caused by longitudinal deviation of the work roll, the UCM is equipped with a work roll shifting function (UCM work roll shifting technology).

For thin gauge production of tin plates, Primetals Technologies supplies PLTCMs with UCM technology and a specially designed coolant spraying system to achieve stable operation with a rolling speed up to maximum 2,000 m/min.

# REVERSING COLD MILLS

## ADVANCED TECHNOLOGY



Reversing cold mill, Tangshan Iron & Steel, Tangshan, China



Reversing cold mill, Borcelik, Turkey

### REVERSING COLD ROLLING MILLS

Depending on the product mix, rolling capacities between 200,000 to 400,000 t/year are possible in a single stand reversing cold mill. Reversing cold mills allow the production of high quality products with the capability of flexible rolling of many kinds of material and thickness combinations. Rolling schedules can be carried out as even or uneven passes in order to maximize mill availability and performance. Primetals Technologies uses flatness measurement systems mounted on both sides of the mill to ensure optimum flatness control.

For requirements of a medium production capacity from 400,000 to 800,000 t/year, 2-stand reversing mills from Primetals Technologies will provide highest quality applications and offer the best possible performance in terms of product quality and productivity.

### MAIN BENEFITS

- High production capacity and yield
- Flexible, low cost rolling of a wide range of products, especially for small order lots
- Tight strip thickness and strip flatness tolerances
- Minimum off-gauge length
- Quick start-up



# SKIN-PASS MILLS FOR A PERFECT FINISH



Skin-pass mill, ArcelorMittal, Sparrows Point, USA

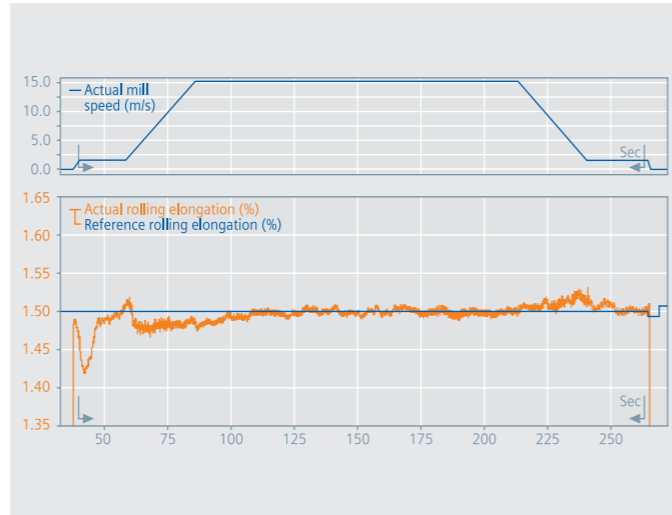

Elongation control with optimized compensation

## SKIN-PASS MILLS

The advantages of skin-pass mills include full compliance with tight strip elongation tolerances, excellent flatness performance, uniform surface roughness for coating applications and the availability of wet and dry skin-passing modes. Both stand-alone and inline skin-pass mills are supplied in either single- or 2-stand design for adjusting the final mechanical properties, flatness, and surface finish of cold-rolled strip.

To meet the continually increasing demands for strip flatness, elongation, and roughness, especially for hard material grades such as advanced high strength steel for automotive applications, Primetals Technologies installs 6-high and 4-high skin-pass mills used for rolling from soft to middle and hard grade material. They can also be equipped with dry and wet temper modes.

## SKIN-PASS CONTROL TO MEET HIGHEST QUALITY DEMANDS

The expectations of end customers for steel are constantly rising. Deep-drawing sheet steel, for example, needs to be flat and should not exhibit any stretcher strains. All this makes skin-pass rolling an important process that calls for optimization. The skin-pass control of Primetals Technologies with self-optimizing parameters can help you master these challenges:

- Different modes to suit different requirements
- Skin-pass control via the rolling force
- Skin-pass control via the strip tension
- Skin-pass control in mixed tension force mode
- Skin-pass control based on the patented advanced mass-flow concept

This results precisely in the uniform elongation and texture of the entire strip that your customers expect. And what is more, our process models always keep the skin-pass mode under control, whether for 2-stands or single-stand lines.

# DOUBLE COLD REDUCTION MILLS FLEXIBLE ROLLING



Double cold reduction mill/temper mill, Baosteel, Baoshan, China



Temper mill, WIN Steel, Wuhan, China

## DOUBLE COLD REDUCTION MILLS

Double cold reduction (DCR) mills are mainly used for tin plates products (DR products), and are designed to meet the customer's requirements for double cold reduction and 2-stand temper rolling. The double cold reduction process reduces the annealed strip on the no. 1 mill stand and temper-rolls the strip on the no. 2 mill stand. This process imparts the desired mechanical strength to the strip to be set in the first pass and the target surface characteristics in the second mill stand.

In 2-stand temper rolling, the strip is temper-rolled in both the no. 1 and no. 2 mill stands to the required elongation ratios in order to obtain the desired mechanical characteristics.

Primetals Technologies has designed 6-high mills for mill stands with heavy reduction capacity, excellent strip flatness controllability and stable rolling.

## OPERATION MODES OF DCR/TEMPER MILLS

Tin plate has various grades of thickness, hardness, and surface roughness. To produce wide ranges of tin material, Primetals Technologies provides proven flexible operation modes. The combination of reduction and wet temper mode is the most typical rolling mode for the production of DR-6 to DR-10 grades of tin material. Stand no. 1 reduces the thickness at 1 or 2% more effectively than reduction rolling technology, while stand no. 2 applies temper rolling to reduce to final thickness, the required surface roughness, and excellent flatness. Two times temper rolling is used to produce T-1 to T-5 grades with high speed.

No.	Operation mode	No. 1 mill	No. 2 mill
1	DCR	Reduction (emulsion)	Wet or dry temper
2	Double temper	Wet or dry temper	Wet or dry temper

# MILL STAND TECHNOLOGIES

## THE MOST RELIABLE TECHNOLOGIES

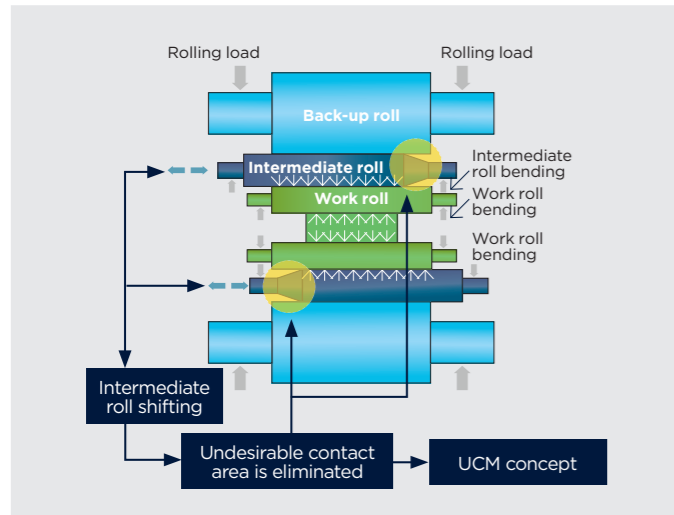

Function principle of a mill stand equipped with UCM technology

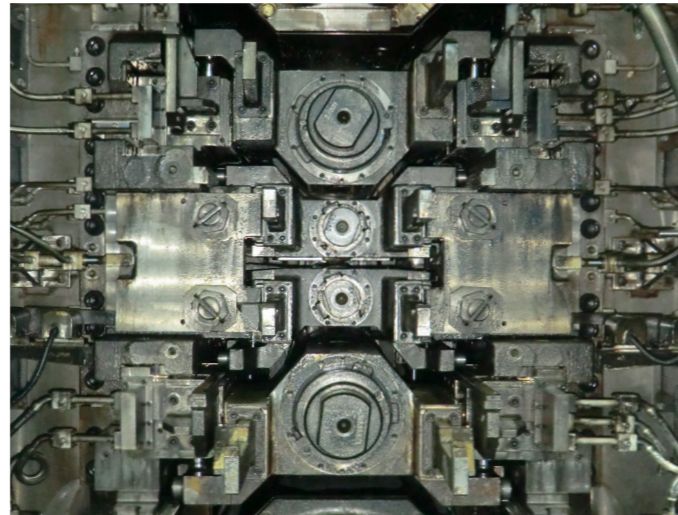

HYPER UCM



HYPER UCM, Maanshan Iron & Steel, China

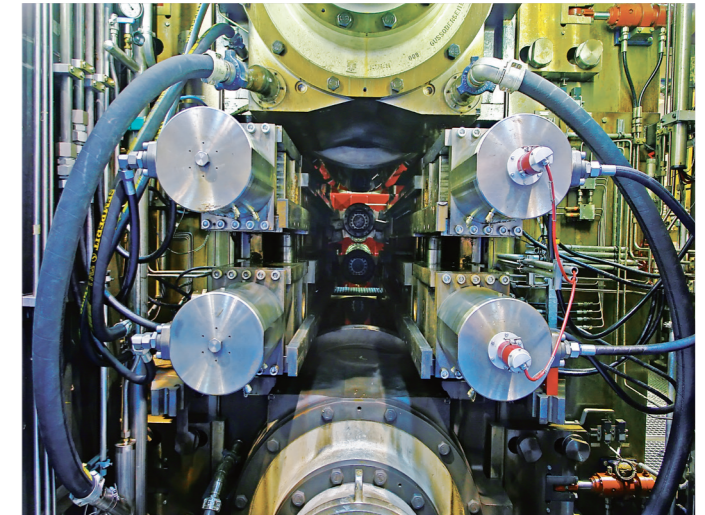

SmartCrown mill housing, voestalpine, Austria

### UCM: THE SIMPLE APPROACH TO BEST PERFORMANCE

Universal Crown Control Mill is based on the idea of correcting flatness and crown defects by the use of shiftable intermediate rolls to significantly reduce the contact area responsible for work roll deflection. The UCM concept for shape control also includes work roll and intermediate roll bending alongside intermediate roll shifting. Parallel crownless rolls are used for direct interaction with the strip; intermediate and back up rolls are designed to support most rolling operations, including the rolling of high-strength steels. Work rolls with a modified shape at the strip edges are used to roll electrical steel which requires a very uniform strip profile. The amount of edge drop in cold rolling can be reduced by dynamically shifting the roll position during rolling and by adjusting the gap between the work rolls. This leads to a higher yield.

UCM technology gives mill operators wider ranges for flatness control and simplifies the work process.

### ADVANTAGES OF THE UCM ROLL ARRANGEMENT

- Reduced work roll deflection
- Straight work rolls can be applied
- Strip crown and edge profile is reduced
- Roll inventory is kept to a minimum
- Use of smaller-diameter work rolls is possible
- Work roll and intermediate roll bending is effective

### UCM FLAT - FLATNESS CONTROL FOR UCM

UCM has infinite width rigidity by shifting the intermediate roll at the strip edge. Flatness remains independent of rolling force variations to prevent the work roll extent deflection effect. Primetals Technologies has put this function to good use for flatness control.

Work roll bending, intermediate roll bending, shifting, leveling, and spot cooling allow for wider flatness control capabilities. Even multidimensional flatness errors caused by disturbances such as incoming material crowns, edge drop, hardness variation, roll thermal crowns, roll wear, and inconstant rolling lubrication will be minimized. Using above features, UCM achieves highly stable rolling in any rolling condition, including flying changes for gauge and width in continuous rolling.

### MATHEMATICAL FLATNESS CONTROL MODEL

Based on online flatness measurements and a selected flatness target curve, the UCM Flat mathematical model calculates required flatness points for each actuator, thus minimizing errors. Actuator movement is distributed between available actuators to reduce mechanical wear in order to prolong the lifetime of the equipment. Topical flatness deviations are removed by a multi-zone coolant spray system, resulting in high quality end products. Changing from low speed to top speed through acceleration/deceleration, UCM Flat manages any flatness disturbance.

### HYPER UCM

The HYPER UCM was developed in response to the recent demand by the automotive industry for advanced high strength steels and high grade, non-grain oriented electrical (silicon) steels. The reduced work roll diameter of this mill type ensures a high reduction capability for harder and wider materials. In order to maintain long-term robustness and high speed operability of the mill, the work rolls are driven directly and no horizontal support rolls are used. The exceptional flatness controllability known from the UCM is also a feature of the HYPER UCM, where it is realized through an optimal selection of the work roll, intermediate roll, and back-up roll diameters. This innovative roll setup with its very specific roll diameters is a decisive factor within the high-performance roll bending system of the HYPER UCM.

- Small work roll diameter, about 20% of strip width, can be applied
- Optimized roll diameter (work roll, intermediate roll, and back-up roll)
- Work roll drive system to achieve high flatness control
- Development of high torque transmission spindle (MH-spindle)

### SMARTCROWN

Excellent flatness results can also be achieved by using the patented SmartCrown® flatness control system that is highlighted by a special roll contour geometry for intermediate and backup rolls. The system offers high performance in terms of profile and higher order shape control. The roll contour coefficients are chosen in such a way that for any roll shifting position the resulting unloaded roll gap profile is always cosine shaped. The cosine shaped roll contours offer an additional degree of freedom in roll contour design. Large varieties of the curves are possible, from simple center/edge buckle control to compound buckle control, by choosing the reference angle of the sinusoidal curve. SmartCrown® work rolls create an identical roll-gap profile and enable continuous adjustment of the roll-gap by work roll shifting. Lateral shifting of the bottle shaped intermediate rolls allows for a continuous, gradual adjustment of the roll gap profile to be achieved. In addition to roll shifting and bending, multi zone cooling in the final mill stand serves as another powerful actuator to correct any remaining shape defects of all orders.

### MAIN BENEFITS

- Easy solution for the revamping of existing 4-high mills
- Wide shape-control range
- Streamlined design
- Easy-to-implement control characteristics

# HZ-MILL

## HIGH EFFICIENCY ROLLING FOR GRAIN ORIENTED SILICON STEEL

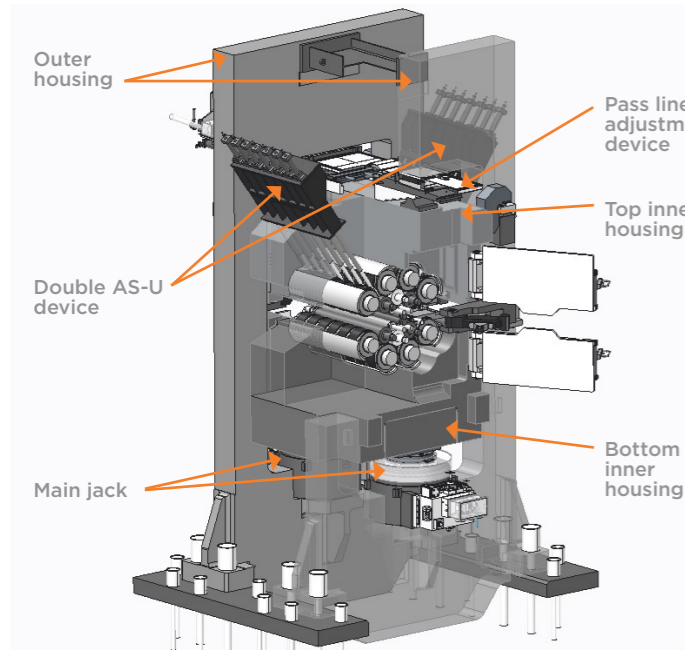

Outer housing

Pass line adjustment device

Top inner housing

Double AS-U device

Main jack

Bottom inner housing

- First double AS-U and intermediate roll shifting during rolling
- High shape control ability (2.4-2.8 times wider than single AS-U)
- Large roll-open clearance (approx. 80 mm)
- Simplified strip threading and easy disposal of broken strip
- More options with roll diameter combinations
- Flexible operation
- High response due to direct AGC cylinder
- Improved gauge accuracy

In a conventional ZR-Mill (ZR), the 20-high rolls are supported in a cluster arrangement and are contained inside a monoblock structure housing. Although this structure is compact, the gap between the upper and lower work rolls is small, and extra work is required in some cases for the threading and strip cutting in case of cobbles.

The HZ-Mill, an advanced 20-high split housing ZR-Mill, utilizes ultra-small diameter work rolls to efficiently roll high-strength materials such as grain oriented silicon and high carbon steel.

The housing is split into an upper and a lower section to create a large gap between the upper and lower work rolls for easy threading and strip removing in case of cobbles.

In addition, unlike with the monoblock ZR, work rolls can be used in nearly their full range regardless of the diameter of the intermediate rolls, in order to achieve greater operability.

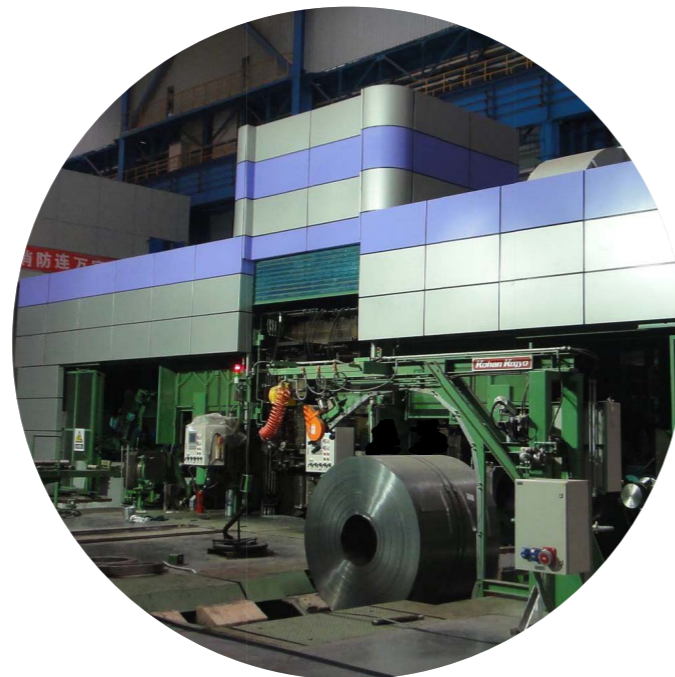

# 4-HIGH/18-HIGH CONVERTIBLE MILL

## SWITCH FROM 4-HIGH TO 18-HIGH MILL

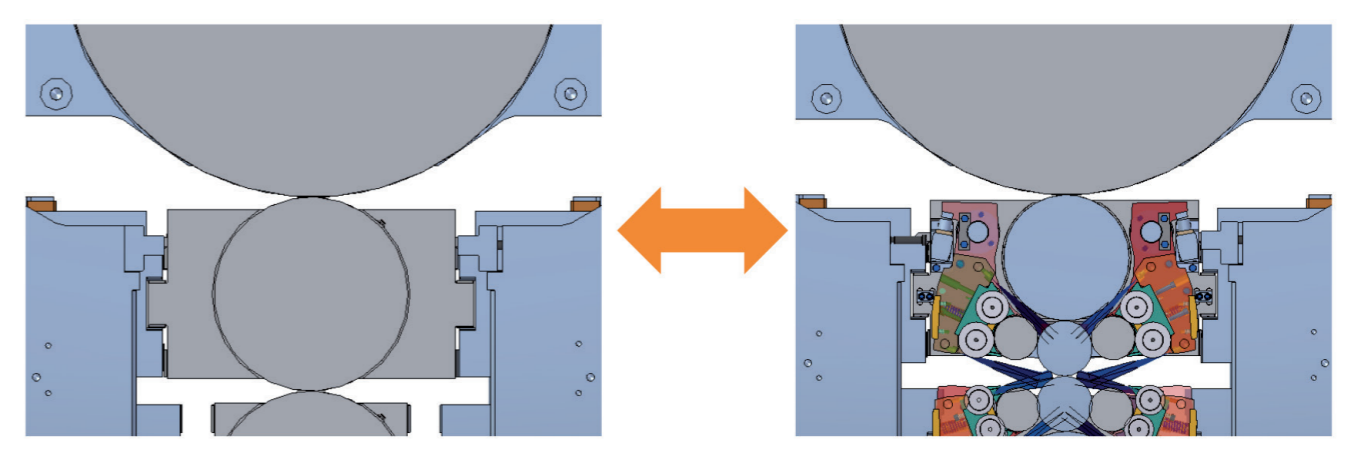

4-high roll configuration, used for rolling the conventional product mix

18-high roll configuration, used to extend the product mix

The 18-high mill configuration is well known for stainless and high carbon steel rolling. Primetals Technologies has introduced the interchangeable mill from 4-high to 18-high to roll a wide range of steel grades from soft materials to advanced high strength steels.

The 4-high mode is suitable for stable rolling of conventional materials at high rolling speeds. The 18-high mode uses work rolls with small diameters and horizontal support rolls, thus the rolling load can be significantly reduced when rolling high strength materials or electrical steels with high silicon contents.

### 4-HIGH/18-HIGH CONVERTIBLE MILLS

The 18-high mill insert consists of driven intermediate rolls, small work rolls and horizontal support rolls on both sides of the work roll. The horizontal support rolls are mounted on moveable arms, which are connected to the intermediate roll chocks. The intermediate roll unit has bending and shifting functions for better flatness control. This simple cassette system makes it possible to change from the 4-high rolling mode to the 18-high mode and back without increasing work roll change time. The back-up rolls remain unchanged and are used in both rolling modes. The quick mode change allows a high flexibility of product mixes.

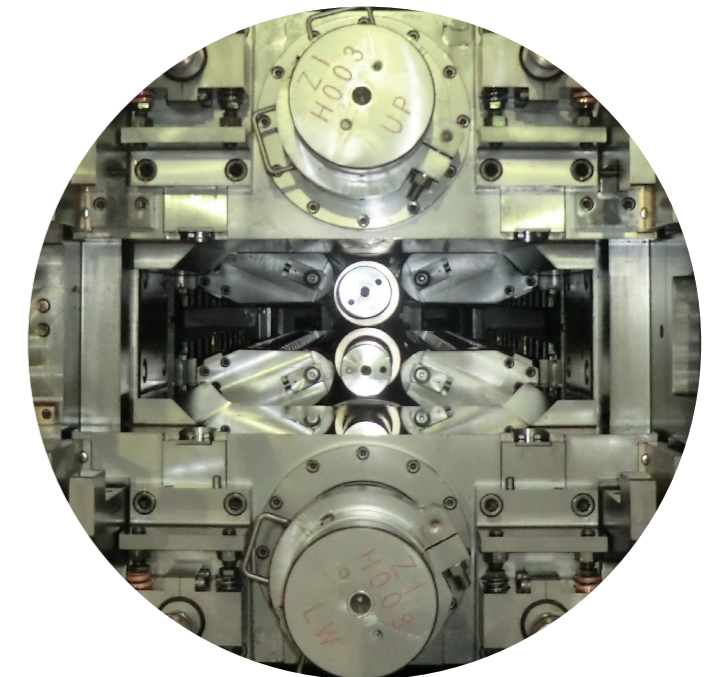



# TECHNOLOGICAL PACKAGES

## UPDATE YOUR MILL TO MARKET REQUIREMENTS

### SIAS

#### AUTOMATIC SURFACE INSPECTION SYSTEM (SIAS®)

Automated inspection systems at the exit of pickling sections, mill sections, or processing lines are becoming common practice. Primetals Technologies offers its own in-house designed automatic inspection system, which consists of a high-resolution single linear camera, LED directional lighting, and a reliable defect recognition system. The purpose of SIAS® is not only to detect strip surface defects but also to protect the mill from damages caused by strip breakage. This is achieved by detecting edge cracks or any non-homogeneity at the mill entry. The system also includes defect classification, live image display, quality reporting, width measuring, and coil grading to support quality assurance.

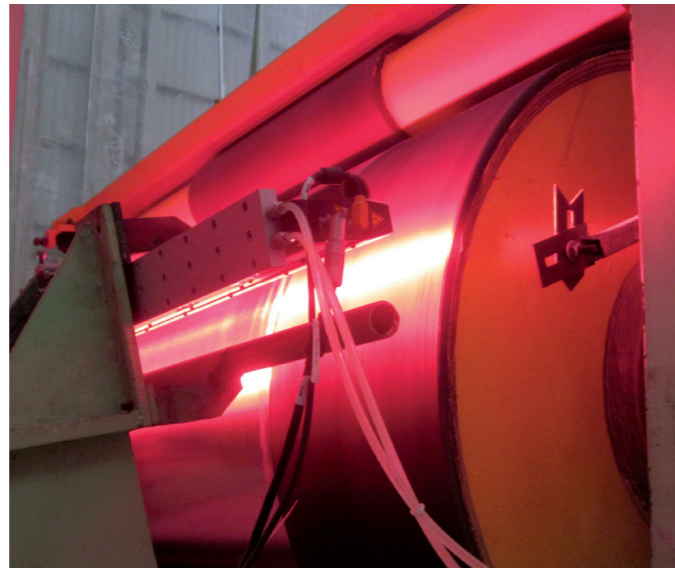

SIAS® surface inspection system, installed in a coupled pickling line and tandem cold rolling mill

### CHATTERBLOCK

#### CHATTERBLOCK EXPERT

A destructive form of mill vibration known as third octave chatter is a serious problem in many cold rolling mills. It often leads to costly damage and reduced mill performance. The new unique anti-chatter system eliminates chatter and allows a mill to operate at higher rolling speeds – even up to maximum mill speed.

By actively exerting a damping effect on the roll force cylinders without hampering the automatic gauge control system of the mill, the rolling mill is brought back into a stable and controllable state.

A new controller algorithm, completely new, highly dynamic servo-valves, and hydraulic design solutions to control vibration frequencies between 90 Hz and 150 Hz have now been developed. Through the suppression of unwanted mill vibration plant operators also benefit from prolonged equipment lifetime, improved product quality, and higher profit margins.

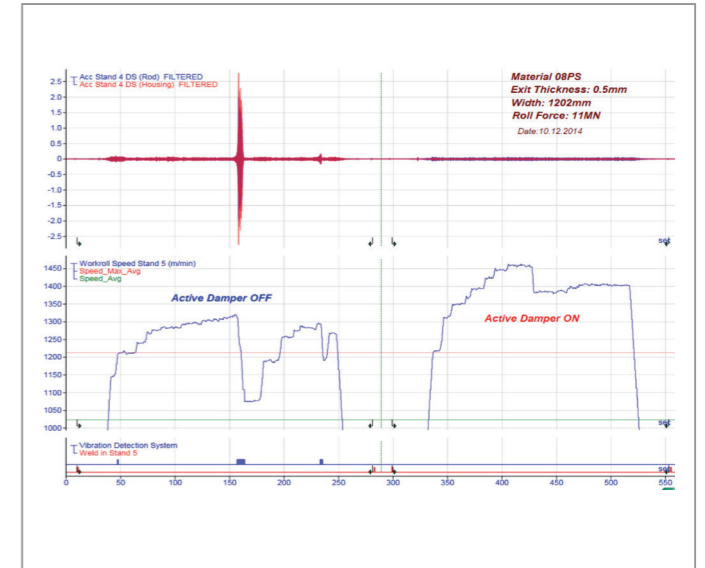

Anti-chatter mode enables higher and more consistent mill speeds (iba measurement system print-out)

### STRIP INSPECTION STATION

#### INSPECTION STATION AT THE EXIT OF A TCM

Efficient two-side inspection is essential for the production of high surface quality materials, especially for exposed automotive sheets. Primetals Technologies offers unique design concepts for inspection stations, such as an inline inspection type at the tension reel exit side, an offline horizontal type, and an offline vertical type. Customized designs are available with consideration to plant operators' individual inspection systems and site.



Surface inspection station at PLTCM, Severstal NA, USA

### MQL

#### MINIMUM QUANTITY LUBRICATION (MQL®)

Demand for new steel grades and higher mill efficiency are driving advances in roll gap lubrication. In cooperation with several industry partners, Primetals Technologies has recently developed MQL® – a considerably improved lubrication solution that contributes to enhanced strip surface cleanliness, reduced rolling forces, lower electrical energy, and decreased specific oil consumption. The system applies pure rolling oil, finely atomized with air directly onto the work roll. The intelligent control of the oil film thickness depends on the rolling process and product parameters. MQL® ensures ideal product specific lubrication, the rapid change of lubrication settings, and a much higher degree of flexibility than classical emulsion systems. Compared to conventional roll gap lubrication with directly applied or recirculated emulsion, MQL® maximizes the level of oil concentration in the bite, and therefore optimizes lubrication performance.

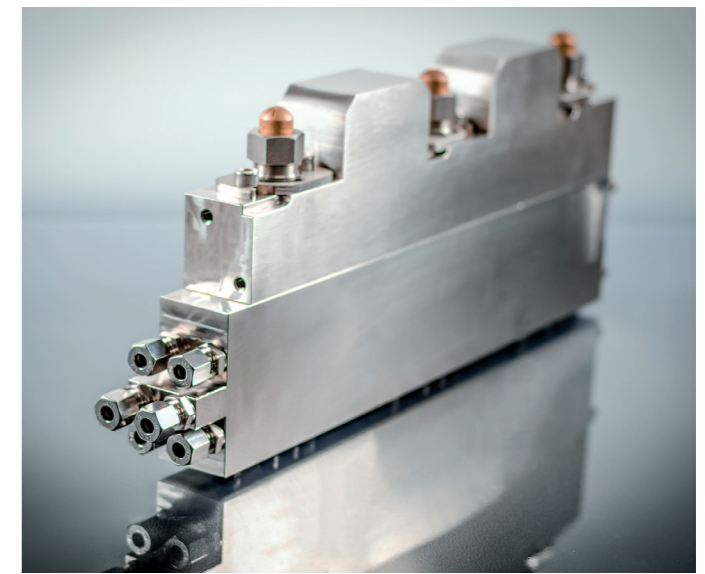

MQL® spray bar

# MILL CONTROL CONTROL AND DRIVES SYSTEMS

Primetals Technologies offers a comprehensive spectrum of cost-effective automation applications, scalable technological control systems and integrated digital drive systems for single stand, 2-stand, and all types of tandem cold mills. Our solutions can significantly improve the production performance and product quality of cold rolling mills, and enable the manufacturing of new steel grades (e.g. for the automotive industry).

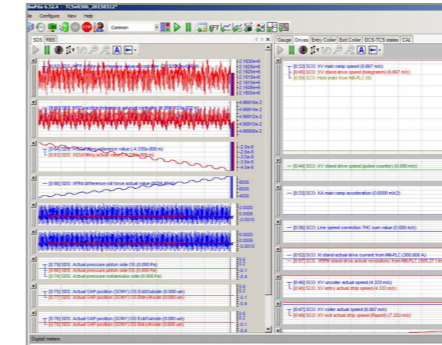
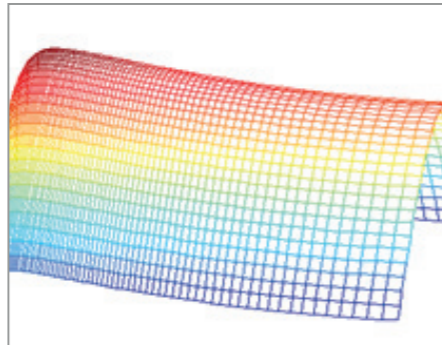

## CONTROL

Technological and model-based controls are at the core of any modern automation concept. Primetals Technologies control systems are outperforming other control systems in the market in many different ways. Continuous improvements and developments ensure that the ever increasing demand for higher throughput and tighter tolerances are met. UCM Flat perfectly complements the mechanical setup of our cold rolling mills. It not only maximizes the utilization of mechanical, electrical, and hydraulics systems, but it also automatically optimizes actuator usage, thus minimizing wear and reducing maintenance.

## MODEL SERVER

The Primetals Technologies model server is at the heart of the automation system. It calculates optimized pass schedules by employing advanced physical process models in connection with innovative adaption techniques such as neural networks. The model server calculates all required rolling parameters such as roll force and roll torque, which are necessary to achieve very small tolerances for flatness and thickness.

## MOTOR AND DRIVES

Primetals Technologies provides a fully digital drives control system at a very high technological level in order to reach superior dynamic performance as well as high reliability and less maintenance. New main drives have been proposed as AC-synchronous motors and induction motors, to achieve minimum motor sizes by using the field weakening capability of the rolling process. The drives will be dimensioned and selected related to higher efficiency. There is no reactive power and low harmonic distortion. The solutions offered for different applications are very flexible and range from single drives with pinion gears to integrated drives systems for tandem drives, and from DC converters to AC inverters, as well as from single drive solutions to multi-drive solutions.

## PROCESS DATA ACQUISITION SYSTEM

The Process Data Acquisition (PDA) system is used for high-speed data acquisition, recording and analysis of analog, digital, and available process values. Data is used for diagnostics, quality reports, and troubleshooting. The PDA system presents a wide range of dialog displays and on-screen menus. These displays incorporate both easy-to-use dialog editing and real-time on-screen recorded-value displays. Overviews and analyses of previously recorded data are also incorporated into this package.

## DIAGNOSTIC SYSTEM

Several new diagnostic features have been added to the control system. One of them is the option to jump directly to the point in the program where the alarm was generated. Everything from the HMI to the plant documentation (including circuit diagrams, user manuals, etc.) can be directly accessed. Both features will greatly shorten fault finding time and reduce mill down time.

## CONDITION MONITORING SYSTEM

Primetals Technologies offers an innovative condition monitoring system called "The Box Concept" that integrates information from several automation levels, metallurgical and automation know-how as well as additional measurement devices such as vibration sensors. By comprehensive analysis, The Box Concept provides a solid basis for high end predictive and proactive equipment maintenance, as well as homogeneous product quality. The Box Concept is modular, user-friendly, and has a short return of investment because of reduced maintenance costs, minimized risk of unplanned shutdowns, and maximized plant availability.

## INDUSTRY 4.0

One of the major goals of Industry 4.0 is the integration of systems in various dimensions: Vertical integration from sensors to IT, horizontal integration along the value chain, and lifecycle integration. Primetals Technologies automation architecture and solutions are rising up to this challenge in order to ensure that your plant is fit for the future. The highest degree of automation in combination with advanced process models and condition monitoring, gets your plant ready for Industry 4.0, and allows easy integration into Primetals Technologies' production and quality management systems.

# COLD MILL COMPLEXES

## EXPERIENCE IS THE BASIS FOR OPTIMIZED PRODUCTION



Cold mill complex for 600,000 t/year

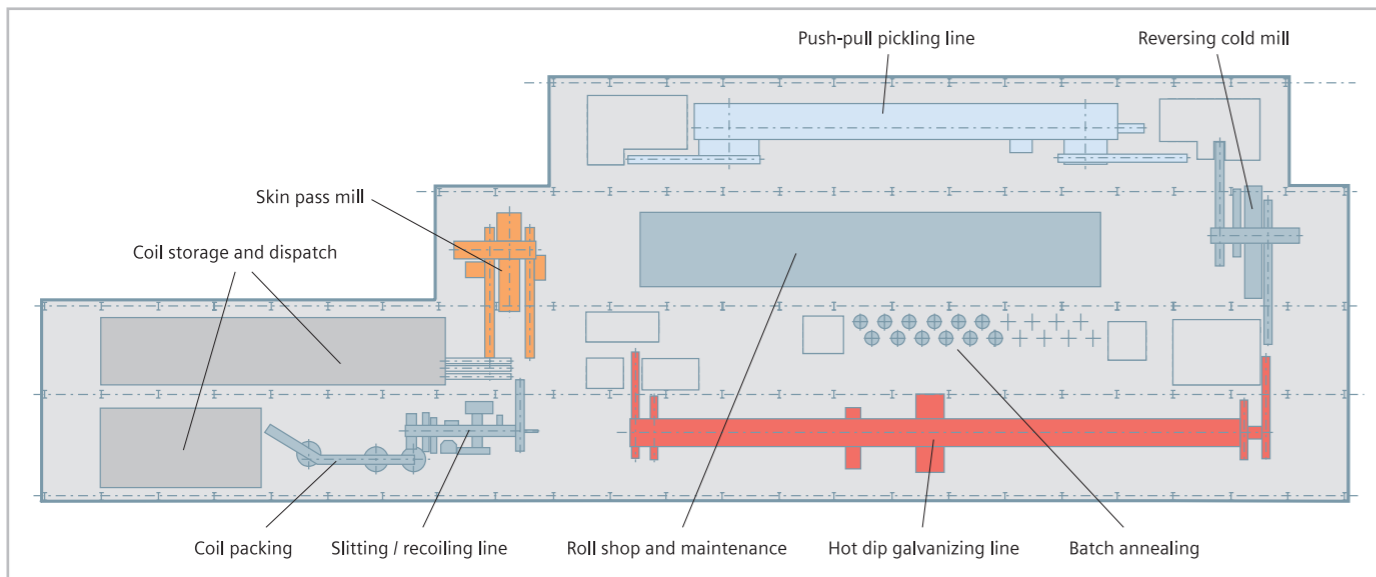

Cold mill complex for 600,000 t/year

Primetals Technologies' outstanding supply record for turnkey cold mill complexes highlights the overall process expertise of the company.

We have supplied tandem cold mills, reversing mills, skin-pass mills, strip processing lines, heat treatment facilities, layout and logistic planning, as well as all related automation and production control (MES) systems and auxiliary facilities (roll shops, storage, finishing lines such as slitting and recoiling lines, packing and dispatch equipment). As part of the scope of services, Primetals Technologies also trains operating and maintenance personnel. In addition, we offer maintenance for the entire plant.

### MAIN BENEFITS

- Single point of responsibility
- Optimized layout solutions for technological key equipment and auxiliary equipment
- Savings in spare parts and maintenance cost over the entire lifecycle

### SELECTED REFERENCES:

- Guangxi Iron & Steel, Fanchenggang, China
- Tangshan Iron & Steel, Tangshan, China
- Pohang Steel Company, Bhubaneswar, India
- TERNIUM Mexico, San Nicolas De Los Garza, Mexico
- POSCO Vietnam, Ba Ria-Vung Tau, Vietnam
- AK Steel, Dearborn, USA
- TATA Steel IJmuiden, IJmuiden, Netherlands
- Asian Color Coated Ispat, Gurgaon, India
- Baoshan Iron & Steel, Shanghai, China
- Maanshan Iron & Steel, Maanshan, China



Pickling line



Tandem cold mill



Reversing cold mill

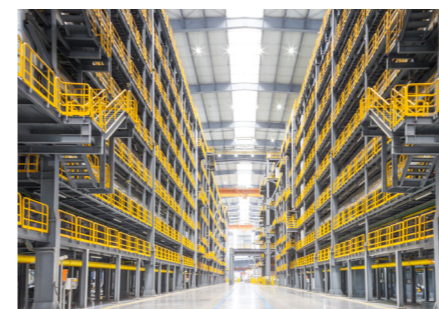

Processing line



Automation



Slitting line



Skin-pass mill



Packing line



Coil storage

# SUPPLY PROJECTS

## MAJOR PLANTS OF THE LAST TEN YEARS

The record of Primetals Technologies to date includes approximately 160 cold mills and process line facilities constructed over the last ten years, equipped with respective mechanical core equipment including electric and automation by one single supplier.

All these plants have in common their strict orientation to highest product quality and material strength level, often in conjunction with higher production capacities to meet the market demands for decades to come. Production routes across the entire cold mill process (interfaces) are optimized based on advanced know-how starting from cold rolling to the final product. One single interface with the customer ensures consistent, fully integrated, and cross-standardized solutions for mill and line equipment, as well as drive and automation systems, and ensures the overall technical responsibility for the entire cold mill complex.



- Reversing and skin-pass mill
- Tandem cold mill



### AUTOMOTIVE STEEL FOR THE U.S. MARKET

**Customer.** Severstal NA (after 2014, AK Steel), Dearborn, MI, USA  
**Type.** New 5-stand, 6-high UCM tandem cold mill linked to a pickling line  
**Our solution.** iBox® pickling tank type and 6-high UCM stands  
**Results.** This solution allows the rolling from soft steel up to high-strength steel grades for applications in the automotive industry.  
**Annual capacity.** 1,860,000 t, start-up: 2010  
**Technical data.** Width: 736-1,830 mm, thickness: 0.37(0.3)-2.67 mm



### 6-STAND TANDEM COLD ROLLING MILL FOR AHSS

**Customer.** Hyundai Steel, Dangjin, Korea  
**Type.** New 6-stand, 6-high UCM tandem cold mill linked to a pickling line  
**Our solution.** iBox® pickling tank type and 6-high UCM stands. Optimized stand numbers achieved by UCM, realizing high reduction and excellent shape.  
**Results.** The solution allows the rolling from soft steel up to advanced high-strength steel grades for applications in the automotive industry.  
**Annual capacity.** 1,500,000 t, start-up: 2013  
**Technical data.** Width: 800-1,650 mm, thickness: 0.3-2.3 mm



### READY FOR TOMORROW'S MARKET

**Customer.** Valin ArcelorMittal Automotive Steel Co. Ltd, Loudi, China  
**Type.** New 4-stand, 6-high tandem cold mill linked to a pickling line  
**Results.** The solution allows the rolling from soft steel up to high-strength steel grades for applications in the automotive industry.  
**Annual capacity.** 1,500,000 t, start-up: 2014  
**Technical data.** Width: 900-1,890 mm, thickness: 0.5-2.5 mm



### 21 MONTHS FROM CONTRACT TO COIL

**Customer.** Tangshan Iron & Steel, Tangshan, China  
**Type.** New 5-stand, 6-high tandem cold mill linked to a pickling line  
**Results.** The line is designed for high-strength, high-quality steels for the automotive industry.  
**Annual capacity.** 1,600,000 t, start-up: 2015  
**Technical data.** Width: 700-1,600 mm, thickness: 0.2-3.0 mm



### VERTICAL STARTUP OF COLD REVERSING MILL

**Customer.** Zhejiang Southeast Metal Sheet, China  
**Type.** Single stand, 6-high UCM  
**Results.** The solution allows the rolling from soft to HSLA grades used for construction and home appliances.  
**Annual capacity.** 250,000 t, start-up: 2010  
**Technical data.** Width: 800-1,300 mm, thickness: 0.18-2.0 mm



### HYPER UCM FOR SILICON STEEL ROLLING

**Customer.** Maanshan Steel, China  
**Type.** Single stand, 6-high HYPER UCM  
**Results.** The solution allows the rolling of high grades of non-grain oriented Silicon steel  
**Annual capacity.** 150,000 t, start-up: 2013  
**Technical data.** Width: 900-1,280 mm, thickness: 0.35-0.65 mm

**Primetals Technologies, Limited**

A joint venture of Mitsubishi Heavy Industries and partners

Chiswick Park  
Building 11 | 566 Chiswick High Road  
London | W4 5YA  
United Kingdom

[primetals.com](https://www.primetals.com)

Brochure No.: T05-O-N024-L4-P-V5-EN

Printed in Austria

© 2021 Primetals Technologies Ltd. All rights reserved

The information (including, e.g., figures and numbers) provided in this document contains merely general descriptions or characteristics of performance based on estimates and assumptions which have not been verified.

It is no representation, does not constitute and/or evidence a contract or an offer to enter into a contract to any extent and is not binding upon the parties. Any obligation to provide and/or demonstrate respective characteristics shall only exist if expressly agreed in the terms of the contract.

These estimates and assumptions have to be analyzed on a case-to-case basis and might change as a result of further product development.

Primetals Technologies excludes any liability whatsoever under or in connection with any provided information, estimates and assumptions. The provided information, estimates and assumptions shall be without prejudice to any possible future offer and/or contract.

Any use of information provided by Primetals Technologies to the recipient shall be subject to applicable confidentiality obligations and for the own convenience of and of the sole risk of the recipient.

Primetals is a trademark of Primetals Technologies Ltd.